

7001iAW and 7400iAW

Hybrid 7000iAW

Air to water heat pumps





Why fit Heat Pumps?

Governments have heat pumps on their technology list to install, with a target of 600,000 a year. This is going to require a 20-fold increase in installers and an opportunity to enter and establish yourself in the market.

For Specifiers and Developers, there is an increased expectation to consider installing heat pumps in domestic properties with government incentives available to support.

**“So quiet, so efficient and easy to install...
It’s a thing of beauty!”**

Jimmy O’Donoghue
Jimmy’s Plumbing & Heating

Engineering

Technical Overview of Heat Pumps

Space and domestic hot water heating with air to water heat pumps

Air to water heat pumps work on the "refrigerator principle". Whereas a refrigerator draws heat out from its interior and pushes it outside, a heat pump draws heat from outside and pushes it inside the house as heat energy. The ambient air is used as a primary regenerative energy source for space heating and domestic hot water. This equates to approx. 75% environmental energy, with the remaining electricity coming from either the grid or from renewable energy sources.

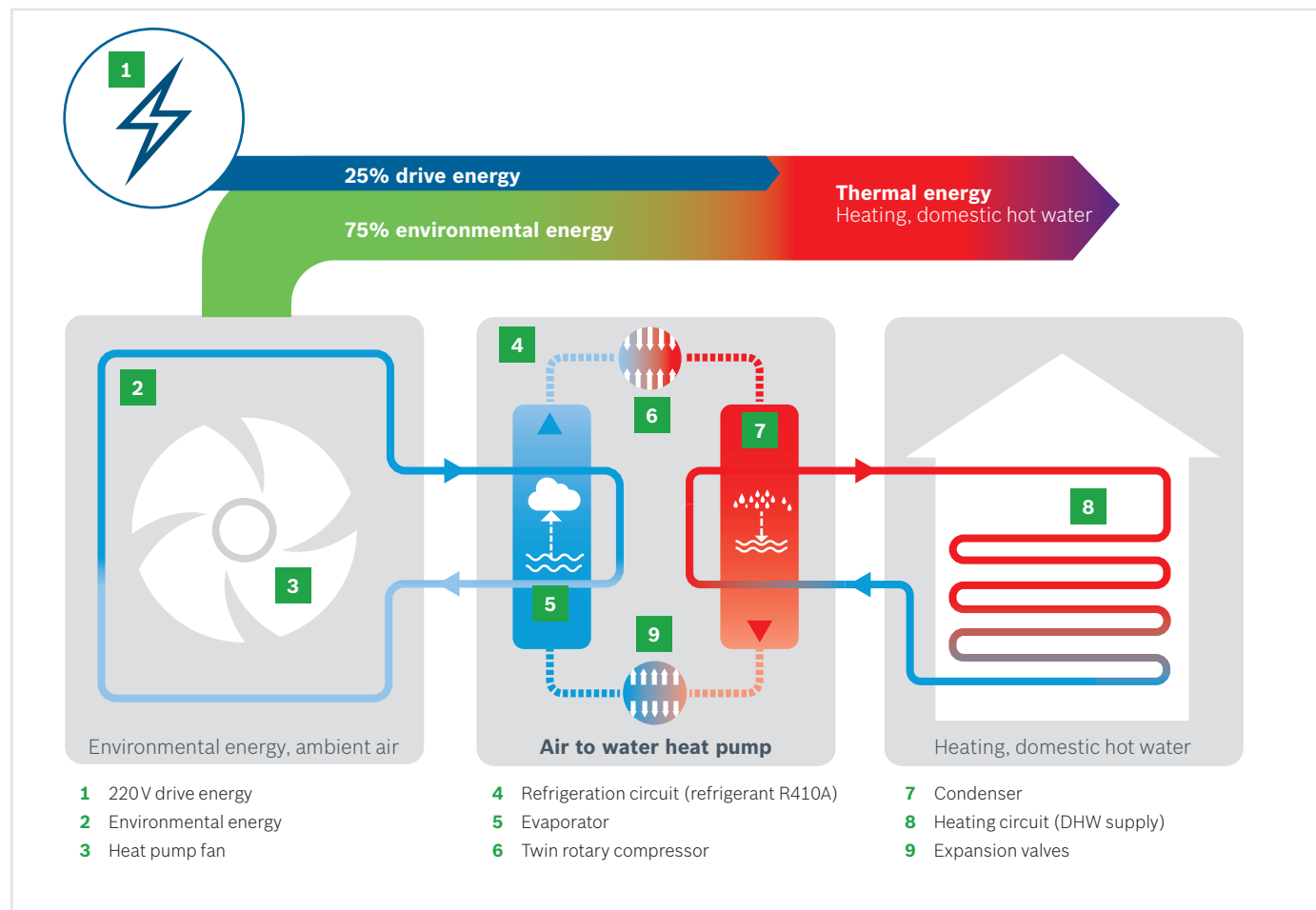

Air to water heat pumps operating principle

1 Power connection

The air to water heat pump needs electrical energy to operate, which is supplied either by utility companies or by a PV system.

2 Environmental energy

The ambient air outside is used as the primary source of energy.

3 Fan

The modulating fan draws in ambient air and discharges cold air from the refrigeration circuit into the environment.

4 Refrigeration circuit

The securely sealed refrigeration circuit ensures the smooth running of heating and cooling operations.

5 Evaporator

Inside the evaporator, the drawn-in air heats the refrigerant until it reaches a gaseous state.

6 Compressor

The compressor, which is driven by an electric motor, uses high pressure to raise the temperature of the refrigerant to approx. 80°C.

7 Condenser

Inside the condenser, the heating circuit absorbs the thermal energy of the gaseous refrigerant, causing it to cool down and return to a liquid state.

8 Heating circuit

The hot water in the heating circuit is approx. 55°C and can be used for heating and for domestic hot water.

9 Expansion valves

By lowering the pressure in the refrigeration circuit, the evaporation reaction (5) is prepared again.

Appliance type

Understanding monobloc versus split system

Air to water heat pumps comprise of either a monobloc and split design. Here's an overview of how they work and perform. Already established in Scandinavia, as well as other countries around the world, learn more about our monobloc 7001iAW and 7400iAW, and its many installation benefits.



Monobloc design

- ▶ Easy installation and quick to integrate into heating hydraulics
- ▶ Complete refrigeration circuit in the outdoor unit
- ▶ Heat production in the outdoor unit (evaporator, compressor, condenser)
- ▶ Heat transfer within the heating circuit in the outdoor unit
- ▶ Low-maintenance, hermetically sealed refrigeration circuit
- ▶ Piping between outdoor unit and indoor unit is a separate hot water circuit
- ▶ Well insulated piping for high efficiency (up to 30m)

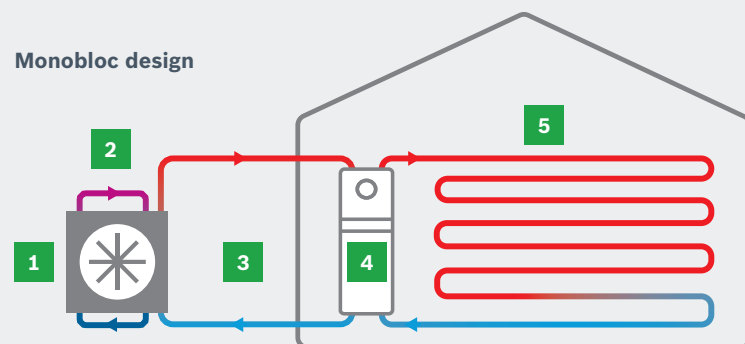

- 1 Heat pump
- 2 Refrigeration circuit
- 3 Heating circuit for heat pump
- 4 Indoor unit
- 5 Heating circuit for house



Split design

- ▶ Advancement of existing split air conditioning units to heat pumps
- ▶ Refrigeration circuit split across two device units
- ▶ Heat production in outdoor unit (evaporator, compressor)
- ▶ Heat transfer in the indoor unit (condenser)
- ▶ Routine leakage tests on refrigeration circuit
- ▶ Piping between outdoor unit and indoor unit is part of the refrigeration circuit
- ▶ Flexible installation options thanks to long pipes (up to 50m)

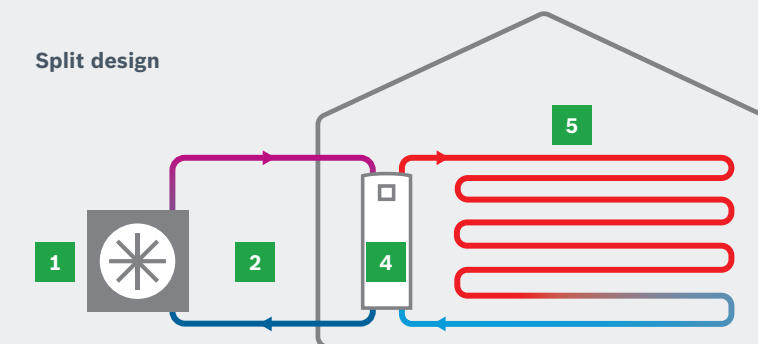

Split design

- 1 Heat pump
- 2 Refrigeration circuit
- 3 Heating circuit for heat pump
- 4 Indoor unit
- 5 Heating circuit for house

Appliance type

Hybrid system

Suitable for renovation (building dependent) and new build projects, our Hybrid 7000iAW unit will operate to run the system in the most efficient way possible based on weather conditions and temperatures. Using the best of both worlds, our hybrid unit will utilise the high efficiency heat pump for central heating, and will call upon the condensing boiler to provide DHW and extra heating into the system - meeting the requirements of many customers who traditionally have used a gas combi boiler. Here's an overview of how the hybrid system will work and perform.

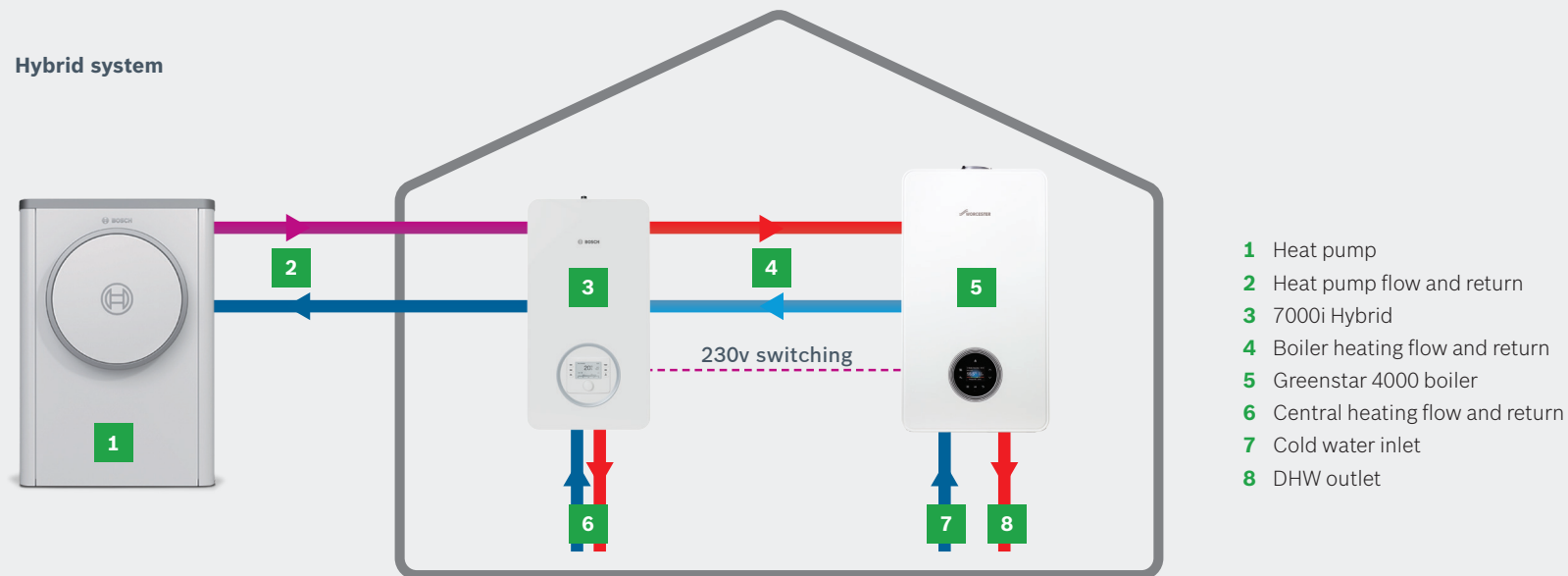

Hybrid design

- ▶ Works with modulating combi boilers
- ▶ Hot water function solely from combi boiler
- ▶ No buffer tank required
- ▶ Integrated mixing valve allows longer operating time of the heat pump
- ▶ Flexible operation between heating mediums offers higher system efficiency
- ▶ Can be set to run parallel (heat pump and boiler at the same time) or individual (heat pump or boiler) dependent of the conditions the system
- ▶ Weighting of the system can be adjusted dependent on gas and electricity prices

System

7001iAW and 7400iAW

Our air to water heat pumps give you a complete system solution bringing together all the elements you need to meet the widest possible range of homes. It means you can be confident the components of any system will work seamlessly together.

Outdoor units

- ▶ 7001i AW outputs between 5 kW and 17 kW
- ▶ 7400iAW outputs 5kW and 7kW
- ▶ A+++ at 35°C flow for heating
- ▶ Quiet Mark certified with ultra low noise in operation
- ▶ Heating mode from -20 °C to 35 °C (outside temperature)
- ▶ Cooling mode from 15 °C to 45 °C (outside temperature)
- ▶ High efficiency due to inverter technology
- ▶ Compatible with electric only and hybrid indoor units
- ▶ Up to 7 years guarantee, terms and conditions apply*.



7001iAW

7400iAW

Indoor units

- ▶ Pre-configured hydraulic units for quick and simple installation
- ▶ Stand alone Green Storage WB Range Heat Pump cylinders for all different DHW applications from 150 to 300 litres
- ▶ AWE wall mounted unit, with outputs up to 17kW, provides quick and easy installation with built in multi-functional back up electrical booster for heating and hot water
- ▶ Up to 7 years guarantee on our AWE and Hybrid 7001iAW unit, terms and conditions apply*.



Green Storage DHW Heat Pump cylinder



AWE with electric booster heater

Compress Hybrid 7000iAW

*For full terms and conditions please visit worcester-bosch.co.uk/heat-pump-tc

Inside the unit

Heat pump and Hybrid components

All important components such as the inverter, and control, filter and circuit boards are also housed in the outdoor unit. The indoor unit can be selected based on the customer's requirements and the operating conditions of the air to water heat pump. Wall-mounted indoor units (AWE) contain the control and the hydraulic components that connect them with the customer's heating and domestic hot water circuits.

Outdoor unit

- 1 Evaporator
- 2 Modulating fan
- 3 Twin rotary compressor
- 4 Condenser
- 5 Two electronic expansion valves
- 6 Inverter
- 7 Weather-proof housing made from EPP

Indoor unit (AWE)

- 8 Integrated IP interface
- 9 High efficiency circulation pump
- 10 Electric booster heater
- 11 Expansion vessel
- 12 Electrical junction box

Indoor unit (Hybrid)

- 13 Control board
- 14 Wiring Centre (230v connections)
- 15 Motorised mixing valve
- 16 High efficiency circulating pump
- 17 Integrated IP interface
- 18 Automatic air vent

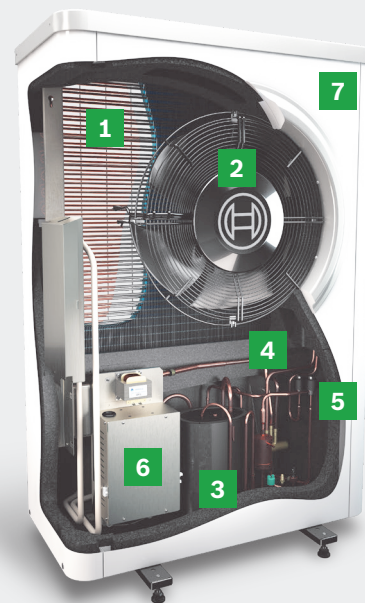

Outdoor unit air to water heat pump

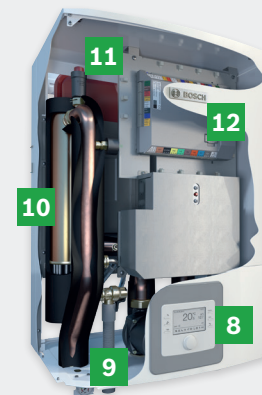

AWE indoor unit

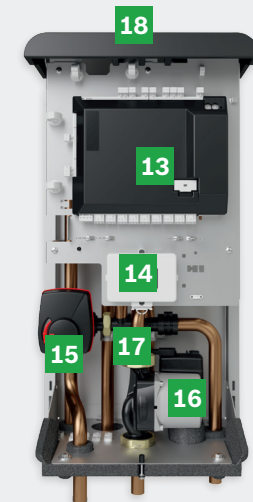



Hybrid indoor unit

System options

AWE wall-hung unit and a DHW cylinder



RETROFIT OR NEW BUILD

-  Suitable for all home sizes including use in urban areas
-  Flexible hot water options to suit most hot water demands

System solutions for demanding lifestyles

The heat demand of a new build or existing property is a decisive factor when choosing the right type of air to water heat pump.

Low temperature heat pumps when combined with underfloor heating or low temperature radiators require less energy to heat any new build home.

The AWE wall hung indoor unit gives system flexibility, with outputs up to 17kW and domestic hot water cylinders options to suit more demanding lifestyles.

System options

Hybrid 7000iAW and a Greenstar combi boiler



**Hybrid
7000i AW**

**Greenstar 4000
boiler**

**CR10H
controller**

**RETROFIT OR
NEW BUILD**

Suitable for small to medium properties

To suit most hot water demands

System solutions for demanding lifestyles

The Hybrid 7000i AW allows the integration of the high efficiency heat pump with the benefits of a gas combi boiler (up to 32kW for heating). Dependant on the climate conditions, the system can operate most effectively with either the Heat Pump the boiler or both when favorable to do so.

The system can be set up to run the boiler and heat pump at the same time, or each appliance can be used individually if required.

It is also possible to adjust the weighting of the system in favour of electricity or gas if the price of fuels change.

Information

Controls

Our air to water heat pumps are controlled and operated via the indoor unit. The HPC 410 control unit is built into the indoor unit of the air to water heat pump. This makes controlling our entire heat pump system simple. The external CR10H room controller is also available for additional user comfort.



CR10H

An easy to use remote control with the HPC410 for room temperature setting. Provides error messages from the heat pump and integrated room humidity sensor for room cooling (when selected).



HPC 410 Control Unit

(integral to indoor unit)



AWE

Hybrid

Information

Quiet Mark certified

Sound levels

The sound level of outdoor air to water heat pumps installed are measured in decibels. Depending on local regulations, residential areas are sometimes subject to specific noise levels during the day and/or at night. Our quietest ultra low noise outdoor unit is Quiet Mark certified.



Cars in city traffic **70 dB**

Children playing **55 dB**

700i AW5 (normal operation, 3 m) **46 dB**

Birds **42 dB**

Refrigerator **40 dB**

700i AW5 (sleep mode, 3 m) **40 dB**

7400i AW5 (normal operation, 3 m) **38.5 dB**

7400i AW5 (sleep mode, 3 m) **34.5 dB**

Whispering **20 dB**



Sound pressure level
at 3 m clearance
(700iAW without sound hood fitted)



Sound pressure level
at 3 m clearance

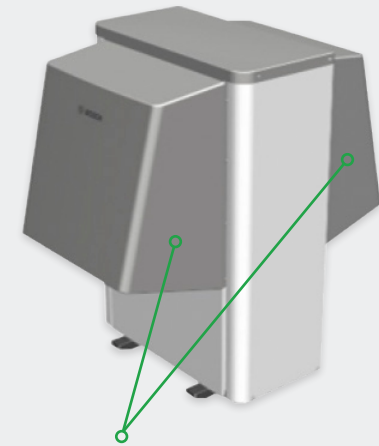

Sound-insulating hood for noise reduction
(Optional accessory for 700iAW)

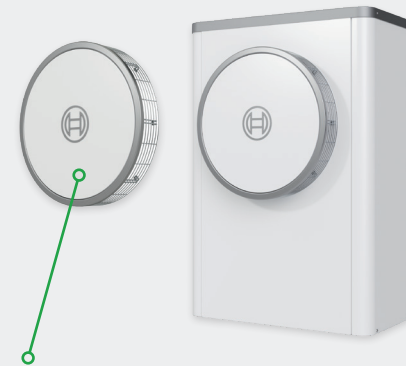

Sound diffuser to reduce noise

Information

System schematics

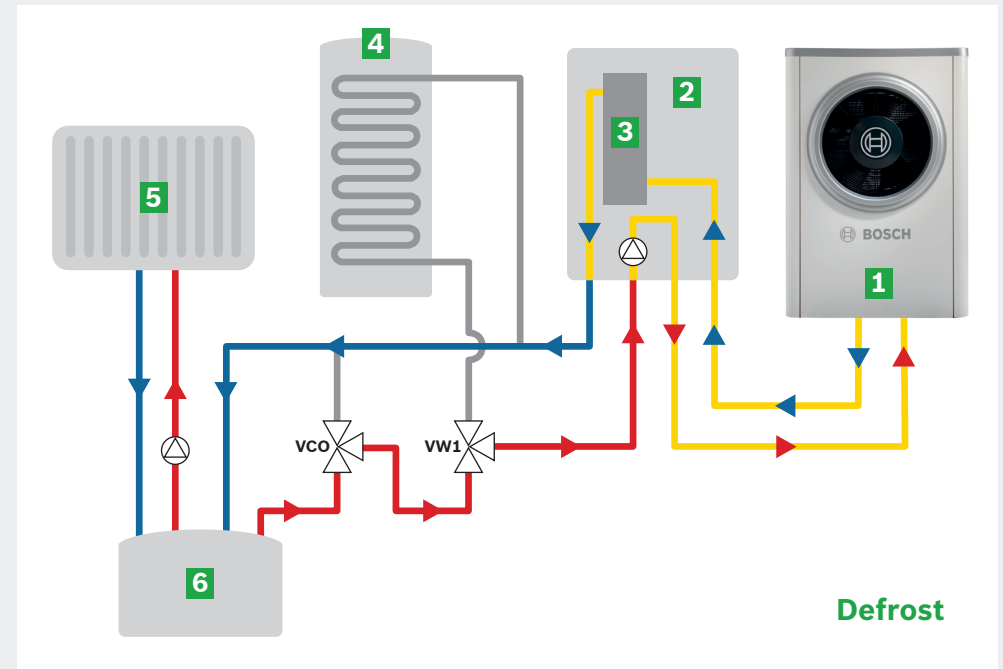
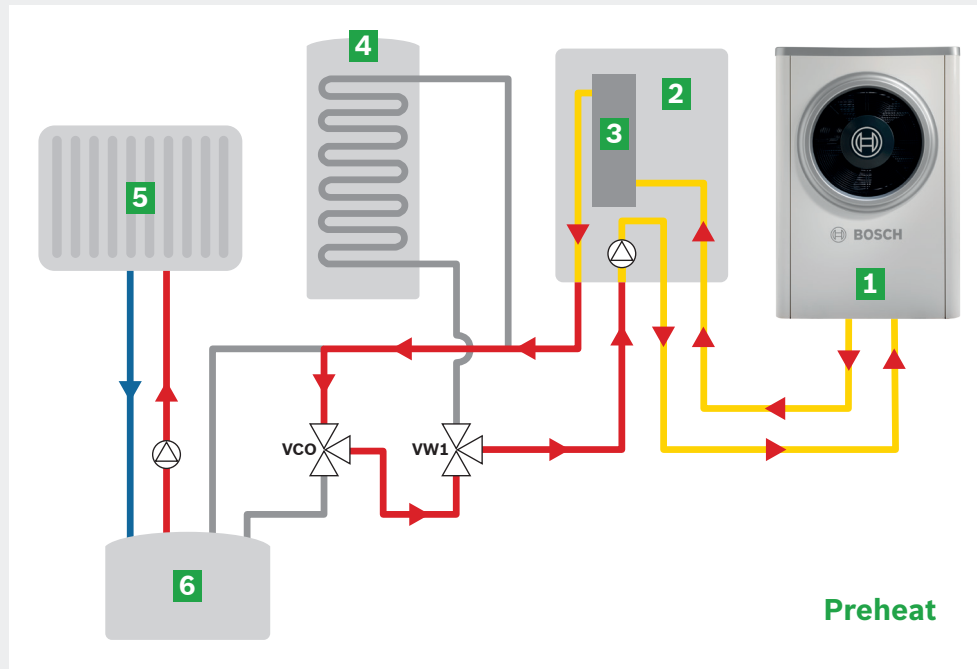

Key

- 1 AW Outdoor unit
- 2 AWE Indoor unit
- 3 Electric booster heater
- 4 Domestic hot water cylinder
- 5 Central heating system
- 6 50l buffer tank

Outdoor unit
Flow and return

Heating flow

Heating return

Information

System schematics

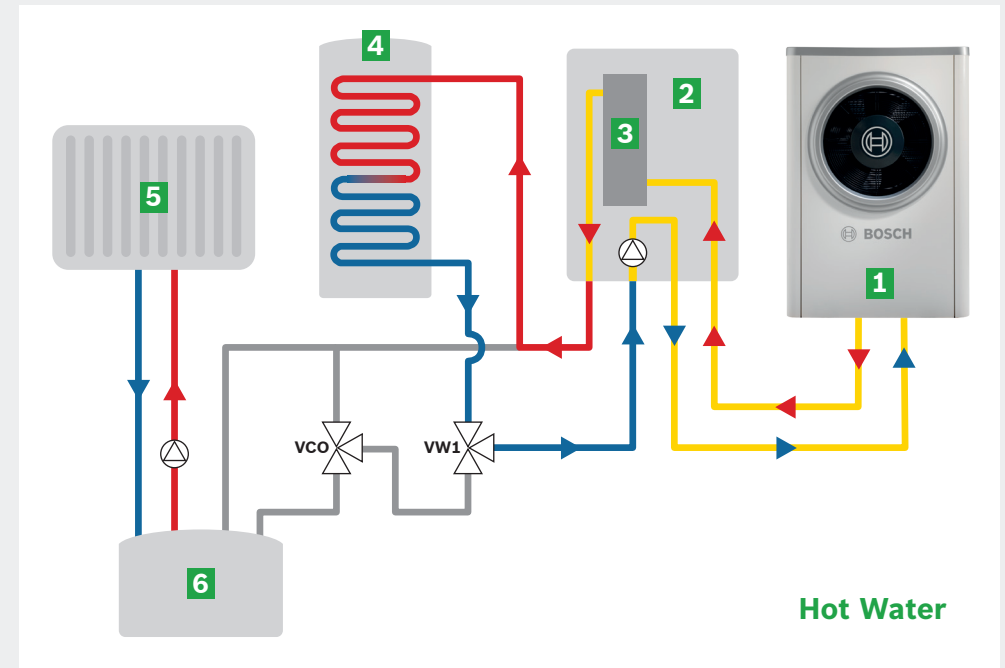
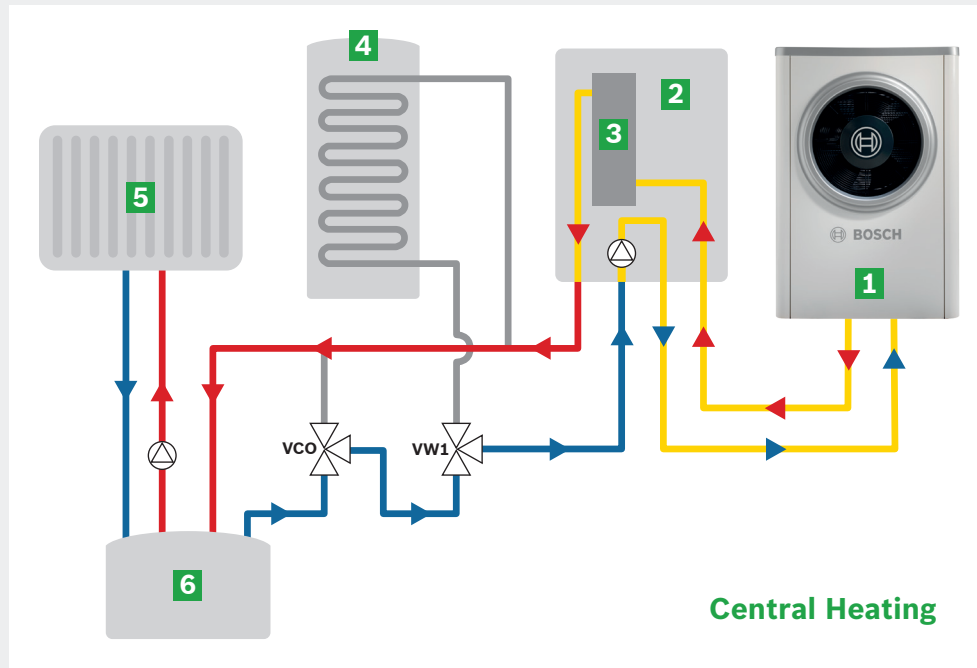

Key

- 1 AW Outdoor unit
- 2 AWE Indoor unit
- 3 Electric booster heater
- 4 Domestic hot water cylinder
- 5 Central heating system
- 6 50l buffer tank

Outdoor unit
Flow and return

Heating flow

Heating return

Information

Technical data

700iAW Technical data

Item	700iAW 5kW	700iAW 7kW	700iAW 9kW	700iAW 13kW	700iAW 17kW
Part number (outdoor unit)	8 738 210 255	8 738 210 256	8 738 210 257	7 738 602 089	7 738 601 998
Part number (indoor unit)	7 738 602 107	7 738 602 107	7 738 602 107	7 738 602 108	7 738 602 108
Energy efficiency class (35°C)	A+++	A+++	A+++	A+++	A+++
Energy efficiency class (55°C)	A++	A++	A++	A++	A++
Coefficient of performance (COP) at +7/W35	4.69	5.31	5.02	4.68	4.87
Seasonal coefficient of performance (SCOP) (35°C)	4.41	4.77	4.57	4.6	3.35
Seasonal coefficient of performance (SCOP) (55°C)	3.22	3.43	3.44	3.38	2.85
Sound pressure level at a distance of 1m dB(A)	39	39	40	47	45
Refrigerant type	R410A	R410A	R410A	R410A	R410A
Compressor type	Twin rotary compressor	Twin rotary compressor	Twin rotary compressor	Twin rotary compressor	Twin rotary compressor
Power supply - outdoor unit	230V 1N AC 50Hz	230V 1N AC 50Hz	230V 1N AC 50Hz	230V 1N AC 50Hz	400V 3N AC 50Hz
Electric booster heater (standard)	Yes	Yes	Yes	Yes	Yes
Working outdoor temperature range (heating)	-20/35°C	-20/35°C	-20/35°C	-20/35°C	-20/35°C
Heating power at A-7/W35*	4.7	5.93	6.21	11.5	13.02

Information

Technical data

7400iAW Technical data

Item	7400iAW 5kW	7400iAW 7kW
Part number (outdoor unit)	7 738 602 075	7 738 602 076
Part number (indoor unit)	7 738 602 107	7 738 602 107
Energy efficiency class (35°C)	A+++	A+++
Energy efficiency class (55°C)	A++	A++
Coefficient of performance (COP) at +7/W35	5.01	5.01
Seasonal coefficient of performance (SCOP) (35°C)	4.73	4.61
Seasonal coefficient of performance (SCOP) (55°C)	3.27	3.47
Sound pressure level at a distance of 1m dB(A)	42	42
Refrigerant type	R410A	R410A
Compressor type	Twin rotary compressor	Twin rotary compressor
Power supply - outdoor unit	230V 1N AC 50Hz	230V 1N AC 50Hz
Electric booster heater (standard)	Yes	Yes
Working outdoor temperature range (heating)	-20/35°C	-20/35°C
Heating power at A-7/W35*	5.0	6.8

*Performance data in accordance with EN 14511

Hybrid 7000iAW Technical data

Item	Hybrid 7000iAW
Compatible with (heat pump)	5kW (8 738 210 255), 7kW (8 738 210 256), 9kW (8 738 210 257)
Dimensions (HxWxD mm)	706 x 350 x 246
Weight (kg)	18
Connections	22mm copper (22mm copper to 3/4" MBSP fittings supplied)
Sound pressure level (dBA)	36
Maximum operating pressure	3 bar
Ingress protection	IPX1D
Heat pump switching	Bosch EMS
Boiler switching	230V
Boiler type	Up to 32kW for heating

Information

Dimensions



7001i AW Outdoor unit



AWE Indoor wall-hung unit



7400i AW Outdoor unit



Hybrid 7000i AW

Information

Parts list



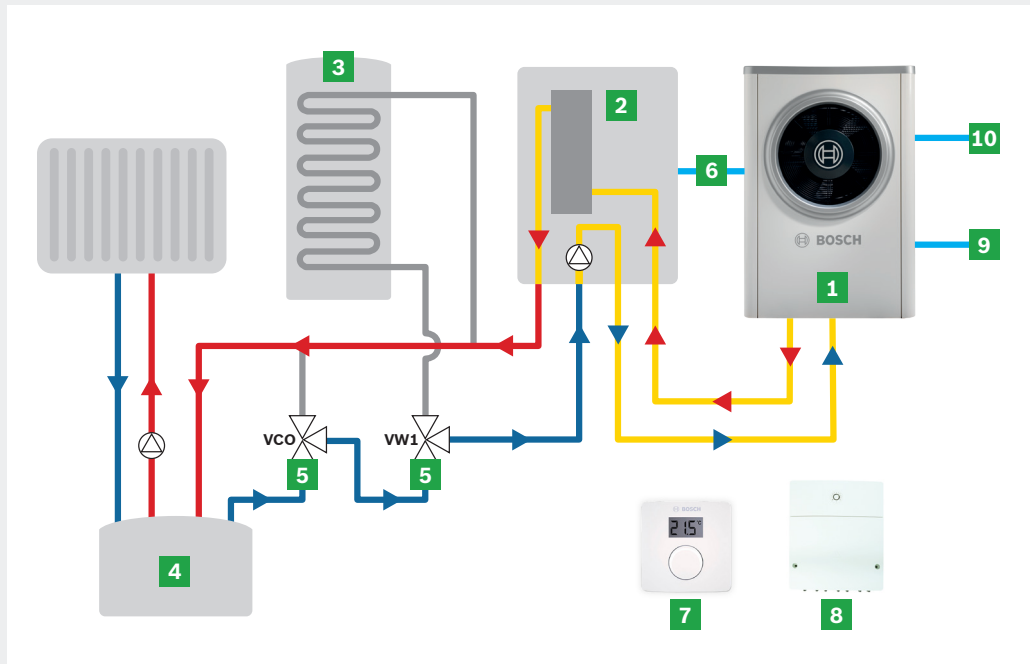



Example system: Compress 700i AW 9kW heat pump system





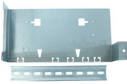



Key	Description	Part Number
1	Outdoor unit 9kW	8 738 210 257
2	Indoor unit 5-9kW (including HPC410)	7 738 602 107
3	Green Storage heat pump (with G3 kit) 210L	7 733 601 334
4	Bosch 50L buffer tank (if required)	7 716 610 61
5	3-way valve (22mm)	8 738 201 412
	3-way valve (28mm)	8 738 201 411
6	CANbus cable 2x2x0.75 ² 15m	8 738 206 183
	CANbus cable 2x2x0.75 ² 30m	8 738 206 184
7	CR10H Controller	7 738 112 314
8	MM100 Mixer (multi-zone controller)	7 738 110 140
9	Heating cable CSC/TS 2m/30W/230V	7 719 003 296
	Heating cable CSC/TS 3m/45W/230V	7 719 003 297
	Heating cable CSC/TS 5m/75W/230V	7 719 003 298
10	Assembly INPA hose	8 733 716 993
Optional accessories available directly from merchant		
11	Rubber feet	See merchant
12	UV and frost protection pipe insulation	See merchant

Information







Accessories









	Description	Part Number
	CR10H Controller	7 738 112 314
	MM100 Mixer	7 738 110 140
	Bracket kit for MM100	8 738 205 073
	Assembly INPA hose	8 733 716 993
	Heating cable CSC/TS 2m/30W/230V	7 719 003 296
	Heating cable CSC/TS 3m/45W/230V	7 719 003 297
	Heating cable CSC/TS 5m/75W/230V	7 719 003 298

	Description	Part Number
	Dew point sensor	7 747 204 698
	22mm 3-way valve (WWV22-1)	8 738 201 412
	28mm 3-way valve (WW28-1)	8 738 201 411
	CANbus cable 2x2x0.752 15m	8 738 206 183
	CANbus cable 2x2x0.752 30m	8 738 206 184
	Sound hood 5-9kW (front)	8 733 709 284
	Sound hood 5-9kW (back)	8 733 709 284

Information

Accessories

	Description	Part Number
	Sound hood 13-17kW (front)	8 733 709 289
	Sound hood 13-17kW (back)	8 733 709 042
	Alarm buzzer	8 738 206 696
	50 litre buffer tank	7 716 161 061
	120 litre buffer tank	7 735 500 777
	150 litre Green Storage WB HP cylinder	7 733 601 189
	180 litre Green Storage WB HP cylinder	7 733 601 333

	Description	Part Number
	210 litre Green Storage WB HP cylinder	7 733 601 334
	250 litre Green Storage WB HP cylinder	7 733 601 335
	300 litre Green Storage WB HP cylinder	7 733 601 336
	Pump group HS25/6 s BO	COMING SOON 7 736 601 142
	Pump group HS25/6 BO	COMING SOON 7 736 601 144
	Pump group HSM25/6 BO	COMING SOON 7 736 601 148
	Pump group HS25/6 MM100 BO	COMING SOON 7 736 601 151
	Pump group HSM25/6 MM100 BO	COMING SOON 7 736 601 155

Information

Training and MCS

Product training

Though you do not need a certain qualification to fit heat pumps, we strongly recommend attending our free of charge product training before carrying out an installation.

Our Monobloc Air to Water course and Hybrid course allows you to have hands-on experience with the appliance, understand all the features and benefits, specification, installation and servicing.

MCS

- ▶ The Microgeneration Certification Scheme (“MCS”) is the UK heat pump industry quality standards and provides access to Government funding and Building Control approval
- ▶ If you want to become MCS certified, you should first identify which Certification Body you wish to be a member of to assess and guide you through the process
- ▶ Each Certification Body has different prices and timescales for the assessment
- ▶ All MCS installers will be assessed against the MCS 001 standard and the specific technical Standard for the technology you wish to become certified for.



Information

MCS made easy

MCS made easy with Alto Energy

Should heat pump installations represent a small proportion of your usual business, obtaining MCS certification represents a significant investment in time and responsibility.

To make entering the heat pump market as easy as possible we've teamed up with Alto Energy, to make your installation MCS compliant.

Key services provided

- ▶ Alto Energy handle all the design work and MCS accreditation paperwork, so you don't have to
- ▶ Full schematics and unlimited telephone support to enable you to complete the installation
- ▶ Fixed, package price for design, supply and commissioning of a heat pump system
- ▶ Handover pack with the necessary certificates for your customer to claim Government grants.



Information

Guarantees







Up to 7 years peace of mind

- ▶ Standard Guarantee - 2 years
- ▶ With product training - 3 years
- ▶ With Alto Energy's MCS umbrella scheme - 7 years

Other guarantee lengths are available depending on your level within our Excelebrate loyalty programme. Please sign up or log in to your account to view a full breakdown of our guarantees.



What's covered

Outdoor unit	Indoor unit	CR10 Control	Hybrid 7001AW
			

Other guarantees

Cylinders	Accessories
	

Cylinder components 5 years and basic vessel 25 years.

Accessories 2 years.

*For full terms and conditions please visit worcester-bosch.co.uk/heat-pump-tc

Information

Good to know

SCOP (Seasonal Coefficient of Performance)

In order to operate, an air to water heat pump must be supplied with energy in the form of electrical current. Together with environmental energy, thermal energy is produced to provide heating and domestic hot water.

An important indicator of a heat pump's efficiency is its SCOP value. This value shows how much thermal energy (in kW) the heat pump produces for every kW of electrical current supplied, averaged out across one year.



The Heat Pump KEYMARK is a voluntary, independent European certification mark for all heat pumps, combination heat pumps and hot water heaters (as covered by Ecodesign, EU Regulation 813/2013 and 814/2013). The certification provides third party test measurements but also includes factory production control and quality management audits. The scheme is now accepted by all participating Certification Bodies.

In Ireland, the HP KEYMARK is an acceptable source of Ecodesign data for heat pumps and is used in the publication of energy performance certificates and building regulation compliance checks.

In the UK, certified products are approved in the eligibility list for the Domestic Renewable Heat Incentive (RHI), therefore HP KEYMARK certification can be used to apply for products to be listed on the MID database.

Outdoor installation

When installing an outdoor unit, minimum distances must be maintained from house walls, pavements and patios. The heat pump should be freely accessible from all sides. Tight or enclosed spaces are best avoided.

Unit-specific measurements can be found in the heat pump's installation instructions.

A concrete foundation with drainage must be provided at the installation site of the outdoor unit. **Ensure that cables and heating pipes running from the outdoor unit to the indoor unit are well insulated.**



Energy consumption labelling

EU directive
(2017/1369)

Air to water heat pumps are heating systems and, depending on the indoor unit connected, can also function as water heaters. As such, they are subject to the EU-wide energy labelling regulations.

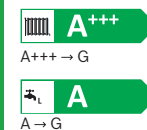

Energy efficiency class A+++ for heating capacity

A+++ → G



Energy efficiency class A for domestic hot water heating

A → G

The labels A → G represent the spectrum of different energy efficiency classes.

Worcester Bosch
Cotswold Way
Warndon
Worcester WR4 9SW

www.worcester-bosch.co.uk

