

# Climate 5000i M

CL5000iM D 21 E | CL5000iM D 26 E

<b>bg</b>	Климатик мулти сплит	Ръководство за обслужване за потребителя . . . . .	2
<b>cs</b>	Multifunkční splitová klimatizační jednotka	Návod k obsluze . . . . .	12
<b>da</b>	Multi-Split-klimaapparat	Betjeningsvejledning til ejeren . . . . .	21
<b>de</b>	Multi-Split-Klimagerät	Bedienungsanleitung für den Betreiber . . . . .	30
<b>el</b>	Κλιματιστικό τύπου Multi-Split	Οδηγίες χρήσης για τον υπεύθυνο λειτουργίας . . . . .	39
<b>en</b>	Multi-Split air conditioner	Operating instructions for users . . . . .	49
<b>es</b>	Climatizador Multi-Split	Manual de servicio para el usuario . . . . .	58
<b>et</b>	Multisplit-kliimaseade	Kasutusjuhend seadme kasutaja jaoks . . . . .	67
<b>fr</b>	Climatiseur Multisplit	Notice d'utilisation destinée à l'utilisateur . . . . .	76
<b>hr</b>	Multi-split klima-uređaj	Upute za uporabu za korisnika . . . . .	85
<b>hu</b>	Multi-split klímakészülék	Kezelési útmutató az üzemeltető számára . . . . .	94
<b>it</b>	Condizionatore multisplit	Istruzioni per l'uso per il gestore . . . . .	103
<b>lt</b>	"Multi-Split" kondicionierius	Naudotojui skirta naudojimo instrukcija . . . . .	112
<b>lv</b>	"Multi-Split" gaisa kondicionēšanas iekārta	Lietošanas instrukcija lietotājam . . . . .	121
<b>mk</b>	Мулти-сплит клима уред	Упатства за ракување за корисникот . . . . .	130
<b>nl</b>	Multi-Split-airconditioning	Handleiding voor de gebruiker . . . . .	140
<b>pl</b>	Urządzenie klimatyzacyjne Multi Split	Instrukcja obsługi dla użytkownika . . . . .	149
<b>pt</b>	Ar condicionado Multi-Split	Manual de instruções para o operador . . . . .	159
<b>ro</b>	Aparat de aer condiționat tip multi-split	Instrucțiuni de utilizare destinate utilizatorului . . . . .	168
<b>sk</b>	Multifunkčné splitové klimatizačné zariadenie	Návod na obsluhu pre prevádzkovateľa . . . . .	177
<b>sl</b>	Multi Split klimatska naprava	Navodila za uporabo . . . . .	186
<b>sq</b>	Kondicioner Multi Split	Manuali i përdorimit . . . . .	195
<b>sr/cnr</b>	Multi-split klima-uređaj	Uputstvo za upotrebu za korisnika . . . . .	204
<b>tr</b>	Multi Split Klima	Kullanım Kılavuzu . . . . .	213
<b>uk</b>	Багатозональна спліт-система кондиціонування	Інструкція з експлуатації для користувача . . . . .	222

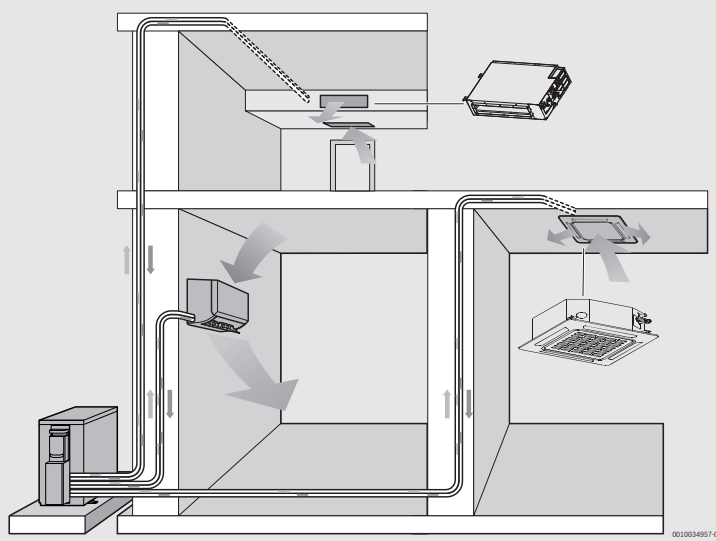

**Table of contents**

**1 Explanation of symbols and safety instructions ..... 49**

1.1 Explanation of symbols ..... 49

1.2 General safety instructions ..... 50

1.3 Notices regarding these instructions. .... 50

---

**2 Product Information..... 51**

2.1 Declaration of conformity ..... 51

2.2 Technical data wired room controller ..... 51

2.3 Specifications of remote control ..... 51

2.4 Operating temperature range ..... 51

---

**3 Operation..... 51**

3.1 Indoor unit overview. .... 51

3.2 Indoor unit display ..... 51

3.3 Overview wired room controllers ..... 51

3.4 Remote control overview ..... 52

3.4.1 Using the remote control ..... 52

3.5 Setting the day and time ..... 52

3.6 Setting main operating mode..... 53

3.7 Setting the room temperature ..... 53

3.8 Setting timer ..... 53

3.8.1 One-time ON/OFF timer ..... 53

3.8.2 Weekly ON/OFF timer ..... 53

3.8.3 Weekly event timer ..... 54

3.8.4 Additional settings for weekly timer ..... 54

3.9 Other functions. .... 54

3.9.1 Switching the key sound on/off ..... 54

3.9.2 Turbo cool/Turbo heat ..... 54

3.9.3 Wireless control function ..... 54

3.9.4 Keylock ..... 54

3.9.5 Follow me function (Follow Me)..... 54

---

**4 Maintenance ..... 55**

4.1 Replacing the batteries ..... 55

4.2 Cleaning ..... 55

4.3 Cleaning the air filter ..... 55

4.4 When re-commissioning after decommissioning for an extended period. .... 55

4.4.1 Maintenance before decommissioning for an extended period: ..... 55

4.4.2 Maintenance after a long period of non -use..... 55

---

**5 Troubleshooting ..... 56**

5.1 Faults with indication (Self diagnosis function) . . . . 56

5.2 Faults not indicated ..... 56

---

**6 Environmental protection and disposal ..... 57**

---

**7 Data Protection Notice ..... 57**

**1 Explanation of symbols and safety instructions**

**1.1 Explanation of symbols**

**Warnings**

In warnings, signal words at the beginning of a warning are used to indicate the type and seriousness of the ensuing risk if measures for minimizing danger are not taken.

The following signal words are defined and can be used in this document:

 **DANGER**

**DANGER** indicates that severe or life-threatening personal injury will occur.

 **WARNING**

**WARNING** indicates that severe to life-threatening personal injury may occur.

 **CAUTION**

**CAUTION** indicates that minor to medium personal injury may occur.

**NOTICE**

**NOTICE** indicates that material damage may occur.

**Important information**

 The info symbol indicates important information where there is no risk to people or property.





Symbol	Meaning
	Warning regarding flammable substances: the refrigerant R32 used in this product is a gas with low combustibility and low toxicity (A2L or A2).
	Wear protective gloves during installation and maintenance work.
	Maintenance by a qualified person should be done while following the instructions of the service manual.
	For operation follow the instructions of the user manual.

Table 1

## 1.2 General safety instructions

### **⚠ Notices for the target group**

These operating instructions are intended for the operator of the air conditioning system. All system-relevant instructions must be observed. Failure to comply with instructions may result in material damage and personal injury, including danger to life.

- ▶ Read and retain the operating instructions of all system components prior to use.
- ▶ Observe the safety instructions and warnings.

### **⚠ Intended use**

The indoor unit is intended for installation inside the building with connection to an outdoor unit and further system components, e.g. controls.

The outdoor unit is intended for installation outside the building with connection to an indoor unit or units and further system components, e.g. controls.

The air conditioning system is intended for commercial/residential use only where temperature deviations from adjusted set points do not lead to damage of living beings or materials. The air conditioning system is not suitable to set and maintain desired absolute humidity levels precisely.

Any other use is considered inappropriate. Any damage that may result from misuse is excluded from liability.

For installation at special locations (underground garage, mechanical rooms, balcony or at any semi-open areas):

- ▶ First refer to the requirements for the installation site in the technical documentation.

### **⚠ General dangers posed by the refrigerant**

- ▶ This appliance is filled with refrigerant. If the refrigerant gas gets into contact with fire, it may generate toxic gas.
- ▶ Have the system inspected and serviced regularly by an approved contractor.
- ▶ If there is a possibility that refrigerant has escaped, thoroughly ventilate the room and notify the approved contractor.

### **⚠ Conversion and repairs**

If modifications to the air conditioning system are not carried out correctly, this can result in personal injury and/or material damage.

- ▶ Have work carried out only by an approved contractor.
- ▶ Do not make any changes to the outdoor unit, indoor unit or other parts of the air conditioning system.
- ▶ Disconnect the air conditioning system from the power supply before carrying out any maintenance work.

### **⚠ Notices on handling the system**

If the air conditioning system is used incorrectly, this could impair your health.

- ▶ Do not stand directly in the airflow for any length of time.
- ▶ Ensure that the room temperature is suitable for all people in the room, including babies, children, elderly, bedridden or disabled people.
- ▶ Never insert objects into the unit, you could injure yourself.

If the unit is handled incorrectly, this can lead to reduced performance and also damage to the unit and personal injury.

- ▶ Do not block the air inlets and outlets of the unit.
- ▶ Shut doors and windows when the unit is in operation.
- ▶ Protect the indoor unit from water ingress.
- ▶ Check the outdoor unit mounting rack periodically for wear and to make sure it is firmly in place.
- ▶ Do not apply any weight to the outdoor unit, e.g. objects or persons.
- ▶ Keep dust, steam and moisture in the installation room of the indoor unit to a minimum.
- ▶ Do not use highly-flammable gases, e.g. from spray cans, in the vicinity of the units.
- ▶ If there appears to be something wrong with the air conditioner (burning smell or faulty cable for example), stop using it immediately and disconnect the power supply.

### **⚠ Safety of electrical devices for domestic use and similar purposes**

The following requirements apply in accordance with EN 60335-1 in order to prevent hazards from occurring when using electrical appliances:

“This appliance can be used by children of 8 years and older, as well as by people with reduced physical, sensory or mental capabilities or lacking in experience and knowledge, if they are supervised and have been given instruction in the safe use of the appliance and understand the resulting dangers. Children shall not play with the appliance. Cleaning and user maintenance must not be performed by children without supervision.”

“If the power cable is damaged, it must be replaced by the manufacturer, its customer service department or a similarly qualified person, so that risks are avoided.”

## 1.3 Notices regarding these instructions

The figures are shown together at the end of these instructions. The text contains references to the figures.

Depending on the model, the products may be different to those shown in these instructions.

## 2 Product Information

### 2.1 Declaration of conformity

The design and operating characteristics of this product comply with the European and national requirements.

 The CE marking declares that the product complies with all the applicable EU legislation, which is stipulated by attaching this marking.

The complete text of the Declaration of Conformity is available on the Internet: [www.bosch-industrial.com](http://www.bosch-industrial.com).

### 2.2 Technical data wired room controller

Power infeed	DC 12V
Permissible ambient temperature	-5 °C... 43 °C
Permissible relative humidity	40...90 %

Table 2 Technical data wired room controller

### 2.3 Specifications of remote control

Power infeed	2 AAA batteries
Signal range	8 m
Permissible ambient temperature	16... 30 °C

Table 3 Specifications of remote control

### 2.4 Operating temperature range

	Room temperature	Outside temperature
Cooling	16 ... 32 °C	-15... 50 °C
Heating	0 ... 30 °C	-15... 24 °C
Dehumidifying	10... 32 °C	0... 50 °C

Table 4



The built-in protection device may prevent the appliance from operating at temperatures outside the above range.



If the humidity is more 80 %, condensation may form at the air outlet. To avoid this, set the fan to a high performance.

## 3 Operation

### 3.1 Indoor unit overview

**Key to Fig. 1:**

- [1] Air inlet
- [2] Electric control box
- [3] Air filter
- [4] Air Outlet

### 3.2 Indoor unit display

**Key to Fig. 2:**

- [1] Manual operation
- [2] Status indicator
- [3] Timer indicator
- [4] Pre-heating and defrosting indicator
- [5] Alarm indicator
- [6] Infrared signal receiver
- [7] LED indicator



The operating modes can be selected in the sequence **automatic mode**, **cooling mode** and **shutdown** via the Manual operation key.

#### Manual button

Operating Mode	Display	Display output
Automatic mode	Operation indicator on	Cooling and heating modes: Set temperature Fan only mode: Indoor ambient temperature
Manual cooling mode	Status indicator flashes	The system automatically switches to automatic mode after 30 minutes of forced cooling. The remote control is deactivated during forced cooling.
Shutting-down	All indicators off	If the display is switched off, the indoor unit switches off and the remote control is reactivated.

Table 5 Indications on the display unit

### 3.3 Overview wired room controllers

**Keys of the wired room controller**

**Key to figure 3:**

- [1] Receiver for infrared remote control
- [2] Display of the wired room controller
- [3] Keys of the wired room controller







Key	Function
	Switch on/off.
<b>M</b>	Set operating mode.
<b>DAYOFF</b>	Day off/deletion.
	Adjust up/down setting.
	Confirm choice.
<b>TIMER</b>	Set timer.
	Fan step
	Navigate back.
	No function.
<b>FUNC.</b>	Set function.
<b>COPY</b>	Copy/adopt data.

Table 6 Keys of the wired room controller

### Display of the wired room controller

#### Key to figure 4:

- [1] Display of main operating modes
- [2] Display of temperature and status
- [3] Display time
- [4] Timer display

Pos.	Symbol	Explanation
<b>1</b>	<b>Display of main operating modes</b>	
		Operating mode: automatic mode
		Operating mode: cooling mode
		Operating mode: dehumidification mode
		Operating mode: heating mode
		Operating mode: Fan Mode
		Operating mode: On/Off
<b>2</b>	<b>Display of temperature and status</b>	
		Value display: shows the current fan speed. There are several output stages (bars) and the <b>AUTO</b> setting for automatic control
		Value display: indicates the set temperature as standard.
		Infographic: keylock
		Infographic: Turbo cool/Turbo heat is active.
		Infographic: room temperature
		Infographic: Follow me active.
<b>3</b>	<b>Time display</b>	
	Value display: indicates time.	
<b>4</b>	<b>Timer display</b>	
		Infographic: timer On/Off
		Infographic: weekdays active
		Infographic: day
		Infographic: week

Table 7 Symbols in the display

### 3.4 Remote control overview

#### Keys on remote control

→ Fig. 5

Pos.	Key	Function
<b>1</b>		Switch on/off.
	<b>Mode</b>	Set operating mode.
<b>2</b>	<b>SET</b>	Select advanced operating functions.
	<b>OK</b>	Confirm choice.
		Set timer.
		Increase temperature.
		Reduce temperature.
<b>3</b>		Fan step
		Indirect airflow is active (Wind avoid me).
	<b>Turbo</b>	Turbo cool/Turbo heat
	<b>LED</b>	Switch display of indoor unit and alarm buzzer on and off (Mute Mode).

Table 8 Keys on remote control

### Display of remote control

→ Fig. 6

Pos.	Symbol	Explanation
<b>1</b>		Operating function: Follow Me function is active (Follow Me); temperature measurement at the remote control.
		Infographic: wireless control function
		Infographic: battery status
<b>2</b>		Operating mode: automatic mode
		Operating mode: cooling mode
		Operating mode: dehumidification mode
		Operating mode: heating mode
		Operating mode: Fan Mode
		Operating mode: Fan Mode
<b>3</b>		Value display: shows the set temperature, fan speed or (when timer is activated) the timer setting as standard.
		Infographic: transmission indicator; lights up when the remote control sends a signal to the indoor unit.
		Infographic: ON/OFF timer active.
		Value display: shows the current fan speed. There are several output stages (bars) and the <b>AUTO</b> setting for automatic control
		Infographic: Turbo cool/Turbo heat is active.
<b>4</b>		Infographic: Turbo cool/Turbo heat is active.

Table 9 Symbols in the display

#### 3.4.1 Using the remote control

The signal range is 8 m. If objects are in the way or certain fluorescent lamps are used in the same room this can affect transmission of the signal.

- ▶ Point the remote control towards the signal receiver window of the device and press the desired key.  
The device emits a beep when it receives a signal.

#### NOTICE

The remote control may be permanently prevented from working correctly.

- ▶ Do not expose the remote control to direct sunlight.
- ▶ Do not leave the remote control near a heating appliance.
- ▶ Protect the remote control from moisture and impacts.

#### 3.5 Setting the day and time

- ▶ Press the **TIMER** key until the timer display starts flashing.
- ▶ Select the current day with the and keys. The selected day flashes.
- ▶ Press the **TIMER** or key to confirm the entry.  
The selection jumps to the time.
- ▶ Press or hold the or key to set the time.
- ▶ Press the **TIMER** or key to confirm the entry.

To toggle between 12- and 24-hour display:

- ▶ Press/keep the **TIMER** and **DAY OFF** keys pressed simultaneously for several seconds.

### 3.6 Setting main operating mode

Depending on the indoor unit and configuration of the wired room controller, not all operating modes may be available.

#### Switching the appliance on/off

- ▶ Press the  key to switch the device on or off:  
The unit starts in the set operating mode or switches off. To protect the unit it can only be switched back on after some time has passed.

Settings can also be made when the appliance is switched off. The device saves the settings, and also retains them in the event of a power failure.

 After it has been switched off, the unit remains in standby mode.

 Following a power failure the unit restarts automatically. This can lead to conflicting readings on the displays which are resolved automatically during operation.



#### Automatic mode

In automatic mode, the unit switches automatically between heating, cooling, fan and dehumidification mode, depending on the set temperature.

- ▶ Press the **M** key repeatedly until  appears on the display.
- ▶ Press the  $\wedge$  or  $\vee$  key to set the required temperature.

 The fan speed cannot be adjusted in automatic mode.

#### Cooling mode



- ▶ Press the **M** key repeatedly until  appears on the display.
- ▶ Press the  key until the required air speed is reached.
- ▶ Press the  $\wedge$  or  $\vee$  key to set the required temperature.

#### Dehumidification mode

- ▶ Press the **M** key repeatedly until  appears on the display.
- ▶ Press the  $\wedge$  or  $\vee$  key to set the required temperature.



 The fan speed cannot be adjusted in dehumidification mode.

#### Heating mode

- ▶ Press the **M** key until  appears on the display.
- ▶ Press the  $\wedge$  or  $\vee$  key to set the required temperature.
- ▶ Press the  key until the required air speed is reached.

 If the outside temperature is very low, the heating capacity of the air conditioning system may not be sufficient. We recommend connecting additional heat sources.

#### Fan (Only) Mode

- ▶ Press the **M** key repeatedly until  appears on the display.
- ▶ Press the  key until the required fan speed is reached. **AUTO** can be selected to enable automatic control.

 The temperature cannot be adjusted or displayed in fan mode.



### 3.7 Setting the room temperature

- ▶ Press the  $\wedge$  or  $\vee$  key to set the desired room temperature. The setting is applied shortly afterwards.

 The temperature cannot be adjusted in Fan Mode.

### 3.8 Setting timer





#### 3.8.1 One-time ON/OFF timer

- ▶ Press the **TIMER** key repeatedly until the corresponding symbol appears.
  - ON timer: **ON DAY**
  - OFF timer: **OFF DAY**
  - ON and OFF timer: **ON+OFF DAY**
- ▶ Confirm with  key. The clock display starts flashing.
- ▶ Press the  $\wedge$  or  $\vee$  key to set the desired ON/OFF time.
- ▶ Press the  key again to save the setting.

 The ON/OFF timer cannot be set at a secondary wired room controller.

#### 3.8.2 Weekly ON/OFF timer

##### Setting timer

- ▶ Press the **TIMER** key until **WEEK 1** appears in the display.
- ▶ Confirm with  key.
- ▶ Press the  $\wedge$  or  $\vee$  key to select the weekday.
- ▶ Confirm with  key.
- ▶ Press the  $\wedge$  or  $\vee$  key to set the desired ON time.
- ▶ Confirm with  key.
- ▶ Press the  $\wedge$  or  $\vee$  key to set the desired OFF time.
- ▶ Confirm with  key.

 Up to four times can be set.

- ▶ Repeat procedure every subsequent day of the week.

To delete the timer for the selected day:

- ▶ Press the **DAY OFF** key.



##### Activating the timer

- ▶ Keep pressing the **TIMER** key until **WEEK 1** appears in the display. The timer is now switched on. The unit is switched on or off at the selected times and days.

##### Deactivating the timer

- ▶ Keep pressing the **TIMER** key until **WEEK 1** disappears in the display.

To switch off the unit when the week timer is active:

- ▶ Briefly press  key. The unit switches off until the next ON timer is reached.
- ▶ Hold the  key pressed for two seconds to switch off the unit and deactivate the week timer.

##### Programming the switch-on delay

If week timer 1 is active and the ON time is to be delayed.









- ▶ Select week timer 1 with **TIMER** key.
- ▶ Press the **DAY OFF** key 2x until 1h appears on the display.
- ▶ Wait for a few seconds while the setting is saved. The unit now starts the next activity cycle following a delay of 1 hour.
- ▶ Press the **DAY OFF** key 3x until 2h appears on the display. The unit now starts the next activity cycle following a delay of 2 hours.

### 3.8.3 Weekly event timer

#### Setting timer





Up to 8 events can be set for each day to change the operating mode, temperature and fan speed.

- ▶ Keep pressing the **TIMER** key until **WEEK 2** appears in the display.
- ▶ Confirm with  key.
- ▶ Press the  or  key to select the weekday.
- ▶ Confirm with  key.
- ▶ Press the  or  key to select the setting time, main operating mode, temperature or fan speed for the event.
- ▶ Confirm with  key.
- ▶ Make the setting and press the  key to confirm or the **DAY OFF** key to delete the setting.
- ▶ Repeat the procedure to define additional setting periods for this day.
- ▶ Follow the same procedure to program additional weekdays.



To delete the timer for the selected day:

- ▶ Press the **DAY OFF** key.

#### Defining the setting time

- ▶ Press the  or  key to adjust the time.
- ▶ Confirm with  key.



#### Selecting the main operating mode

- ▶ Press the  or  key to select the main operating mode (→ Table 7, [1], page 52) ).
- ▶ Confirm with  key.





The fan speed cannot be adjusted in automatic and dehumidification mode.

#### Setting the room temperature

- ▶ Press the  or  key to set the desired room temperature.
- ▶ Confirm with  key.

#### Fan step

- ▶ Press the  or  key to adjust the fan step.
- ▶ Confirm with  key.



The temperature cannot be adjusted in Fan Mode.

#### Activating the timer

- ▶ Press the **TIMER** key until **WEEK 2** appears in the display.  
The timer is now switched on. The unit will adjust itself automatically on these selected times and days.



#### Deactivating the timer

- ▶ Press the  or **TIMER** key for several seconds.

### 3.8.4 Additional settings for weekly timer

#### Provisionally disabling the timer

To disable the timer on selected days only:







- ▶ Press the **TIMER** key until **WEEK 1** or **WEEK 2** appears in the display.
- ▶ Press the  key.
- ▶ Press the  or  key to select the weekday.
- ▶ Press the **DAY OFF** key.  
The selected day is no longer displayed.



The timer is deactivated for the days that are not displayed until the day has passed.

- ▶ Press the **DAY OFF** key again to display the day once again.
- ▶ Repeat the above if necessary for the other days.

#### Adopting (copying) settings from one day to another day

- ▶ Press the **TIMER** key until **WEEK 1** or **WEEK 2** appears in the display.
- ▶ Press the  key.
- ▶ Press the  or  key to select the day whose settings should be adopted.
- ▶ Press the **COPY** key to copy the settings.  
**CY** appears on the display.
- ▶ Press the  or  key to select the day to which the settings should be copied.
- ▶ Press the **COPY** key to insert the copied settings.  
The selected weekday flashes briefly as confirmation.
- ▶ Repeat the above steps if necessary to copy the information to other days.
- ▶ Press the  key to adopt the changes.

## 3.9 Other functions

### 3.9.1 Switching the key sound on/off

To switch the key sound of the wired room controller on or off:

- ▶ Press and hold the  and **FUNC.** keys for three seconds.

### 3.9.2 Turbo cool/Turbo heat

When Turbo cool/Turbo heat is active, the indoor unit operates at maximum power to heat or cool the room quickly.

Turbo Cool:

- ▶ Switch on cooling mode.
- ▶ Press the **FUNC.** key.
- ▶ Confirm with  key.

Turbo Heat:

- ▶ Switch on heating mode.
- ▶ Press the **FUNC.** key.
- ▶ Confirm with  key.

Exiting the function:

- ▶ Press the **FUNC.** key again.
- ▶ Confirm with  key.

### 3.9.3 Wireless control function

The purpose of this function is to establish a connection via WLAN.



To connect to WLAN an IP-Gateway (optional accessory) must be installed.

### 3.9.4 Keylock



The keys of the wired room controller can be locked with the keylock.

To switch the keylock on or off:

- ▶ Press/keep the **TIMER** and **COPY** keys pressed simultaneously for three seconds.  
The symbol  appears in the display when the keylock is active.

### 3.9.5 Follow me function (Follow Me)

This function activates the temperature sensor of the wired room controller. The room temperature is measured at the position of the wired room controller instead of at the indoor unit.

- ▶ Switch off heating or cooling mode if required.
- ▶ Press the **FUNC.** key to switch the function on or off.  
When the function is active the wired room unit displays the  symbol.
- ▶ Confirm with  key.

## 4 Maintenance



### CAUTION

#### Danger due to electric shock or moving parts

- ▶ Disconnect the power supply before carrying out any maintenance work.
- ▶ Have any maintenance steps that are not listed here carried out by an approved installer.

### 4.1 Replacing the batteries

You require 2 size AAA batteries. Using rechargeable batteries is not recommended.

- ▶ Remove the battery cover (→ Fig. 7).
- ▶ Insert new batteries, ensuring correct polarity.
- ▶ Reinstall the cover.

### 4.2 Cleaning

#### NOTICE

#### Damage to device due to incorrect cleaning!

- ▶ Do not directly splash or pour water onto them.
  - ▶ Do not use hot water, thinner, abrasive powders or strong solvents.
- 
- ▶ Clean control unit by wiping with a soft cloth.
  - ▶ Only have the indoor and outdoor units cleaned or serviced by an approved installer.

### 4.3 Cleaning the air filter

#### NOTICE

The air filter may deform in direct sunlight.

- ▶ Do not expose the air filter to direct sunlight.

Check the air filter every 2 weeks and clean if necessary. Always clean before and after decommissioning for longer periods.

- ▶ Switch off the indoor unit.
- ▶ Pull out the air filter (→ Fig. 8).
- ▶ Wash the air filter with hot water and a mild cleaning agent and dry in the shade.

### 4.4 When re-commissioning after decommissioning for an extended period

#### 4.4.1 Maintenance before decommissioning for an extended period:

- ▶ Clean the air filter of the indoor unit.
- ▶ Leave the fan of the indoor unit running for approx. 24 h in Fan Mode to allow the inside of the appliance to dry.
- ▶ Switch off the indoor unit and disconnect it from the power supply.
- ▶ Protect the devices from dust.
- ▶ Check the outdoor unit at regular intervals. Contact customer service or an authorised service engineer if a fault occurs.

#### 4.4.2 Maintenance after a long period of non-use

- ▶ Wipe the air inlet grille with a clean dry cloth so the indoor unit does not blow out dust.
- ▶ Make sure that the air inlet and air outlet are unobstructed and have not been inadvertently adjusted.
- ▶ Check all cables and connect the power supply.
- ▶ If required, make sure that the air filter is installed.



## 5 Troubleshooting

### 5.1 Faults with indication (Self diagnosis function)

If a fault occurs during operation, the LEDs flash for an extended period or an error code is displayed (e.g. EH 02).

### 5.2 Faults not indicated

If faults occur during operation that cannot be eliminated:

- ▶ Call customer service about the fault, providing details of the device.

If a fault is present for more than 10 minutes:

- ▶ Briefly disconnect the power supply and switch the indoor unit back on.

If a fault persists:

- ▶ Call customer service and provide the fault code and details of the appliance.

Fault	Possible cause
The output of the indoor unit is too low.	Temperature is set too high or too low.
	Air filter is soiled and must be cleaned.
	Unfavourable ambient conditions for the indoor unit, e.g. the ventilation openings of the devices are obstructed, doors/windows in the room are open or the room contains powerful heat sources.
	Low-noise operation is activated and prevents the full output from being used.
Indoor unit does not switch on.	The indoor unit has a safety mechanism to prevent overloading. It may take 3 minutes, until the indoor unit can be restarted.
	The batteries of the remote control are empty.
	The timer is switched on.
Operating mode changes from Cooling or Heating to Fan Mode.	The indoor unit changes operating mode to prevent the formation of frost.
	The set temperature is reached provisionally.
A white mist is coming from the indoor unit.	In humid regions, white mist may appear if there is a significant temperature difference between the indoor air and air-conditioned air.
White mist is emerging from the indoor unit and outdoor unit.	If heating mode is activated directly after automatic defrosting, this can generate white mist due to the higher level of humidity.
There is noise coming from the indoor unit and outdoor unit.	A quiet hissing noise is normal during operation. This is caused by the flow of refrigerant.
	Creaks and squeaks may be heard, as the metal and plastic parts of the device expand or contract during heating/cooling.
	The outdoor unit also emits a range of other noises during operation which is normal.
Dust is being discharged from the indoor unit or outdoor unit.	Dust may accumulate in the devices if they are shut down for an extended period and not covered.
Unpleasant odour during operation.	Unpleasant odours in the air may enter the devices and spread.
	There may be mould on the air filter and it must therefore be cleaned.
The fan of the outdoor unit is not running continuously.	Variable fan control is used to ensure optimum operation.
Operation is irregular or unpredictable or the indoor unit is not responding.	The indoor unit may be affected by interference from mobile radio masts or external signal amplifiers. ▶ Switch the power supply off and back on again.
Air baffle or louvres do not run correctly.	Air baffle or louvres have been adjusted manually or have not been correctly installed.
	▶ Switch the power supply off and check whether the components are engaged correctly.
	▶ Switch the power supply back on again.

Table 10

## 6 Environmental protection and disposal

Environmental protection is a fundamental corporate strategy of the Bosch Group.

The quality of our products, their economy and environmental safety are all of equal importance to us and all environmental protection legislation and regulations are strictly observed.

We use the best possible technology and materials for protecting the environment taking account of economic considerations.

### Packaging

Where packaging is concerned, we participate in country-specific recycling processes that ensure optimum recycling.

All of our packaging materials are environmentally compatible and can be recycled.

### Used appliances

Used appliances contain valuable materials that can be recycled.

The various assemblies can be easily dismantled. Synthetic materials are marked accordingly. Assemblies can therefore be sorted by composition and passed on for recycling or disposal.

### Old electrical and electronic appliances



This symbol means that the product must not be disposed of with other waste, and instead must be taken to the waste collection points for treatment, collection, recycling and disposal.

The symbol is valid in countries where waste electrical and electronic equipment regulations apply, e.g. "European Directive 2012/19/EC on old electronic and electrical appliances". These regulations define the framework for the return and recycling of old electronic appliances that apply in each country.

As electronic devices may contain hazardous substances, it needs to be recycled responsibly in order to minimize any potential harm to the environment and human health. Furthermore, recycling of electronic scrap helps preserve natural resources.

For additional information on the environmentally compatible disposal of old electrical and electronic appliances, please contact the relevant local authorities, your household waste disposal service or the retailer where you purchased the product.

You can find more information here:

[www.weee.bosch-thermotechnology.com/](http://www.weee.bosch-thermotechnology.com/)

### Batteries

Batteries must not be disposed together with your household waste.

Used batteries must be disposed of in local collection systems.

### Refrigerant R32



The appliance contains fluorinated gas R32 (global warming potential 675<sup>1)</sup>) mild combustibility and low toxicity (A2L or A2).

Contained quantity is indicated on the equipment outdoor unit name label.

Refrigerant is hazardous to the environment and must be collected and disposed of separately.

## 7 Data Protection Notice



We, **Bosch Thermotechnology Ltd., Cotswold Way, Warndon, Worcester WR4 9SW, United Kingdom**

process product and installation information, technical and connection data, communication data, product registration and client history data to provide product functionality (art. 6 (1) sentence 1 (b)

GDPR), to fulfil our duty of product surveillance and for product safety and security reasons (art. 6 (1) sentence 1 (f) GDPR), to safeguard our rights in connection with warranty and product registration questions (art. 6 (1) sentence 1 (f) GDPR) and to analyze the distribution of our products and to provide individualized information and offers related to the product (art. 6 (1) sentence 1 (f) GDPR). To provide services such as sales and marketing services, contract management, payment handling, programming, data hosting and hotline services we can commission and transfer data to external service providers and/or Bosch affiliated enterprises. In some cases, but only if appropriate data protection is ensured, personal data might be transferred to recipients located outside of the European Economic Area. Further information are provided on request. You can contact our Data Protection Officer under: Data Protection Officer, Information Security and Privacy (C/ISP), Robert Bosch GmbH, Postfach 30 02 20, 70442 Stuttgart, GERMANY.

You have the right to object, on grounds relating to your particular situation or where personal data are processed for direct marketing purposes, at any time to processing of your personal data which is based on art. 6 (1) sentence 1 (f) GDPR. To exercise your rights, please contact us via [privacy.ttgb@bosch.com](mailto:privacy.ttgb@bosch.com) To find further information, please follow the QR-Code.

1) Based on ANNEX I of REGULATION (EU) No 517/2014 of the European Parliament and of the Council of 16 April 2014.

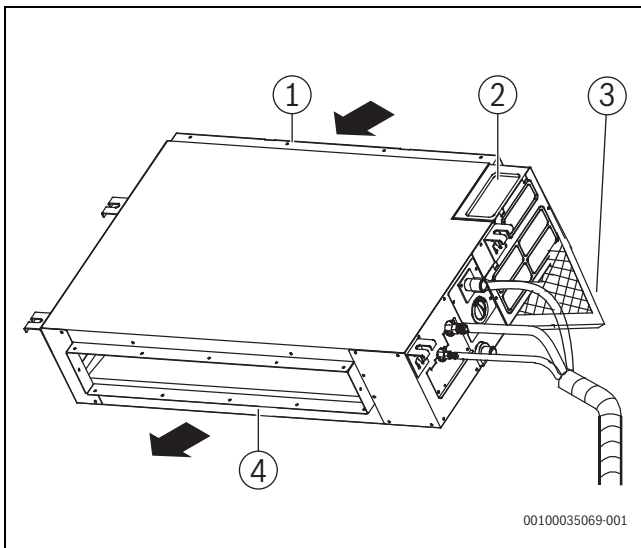

1

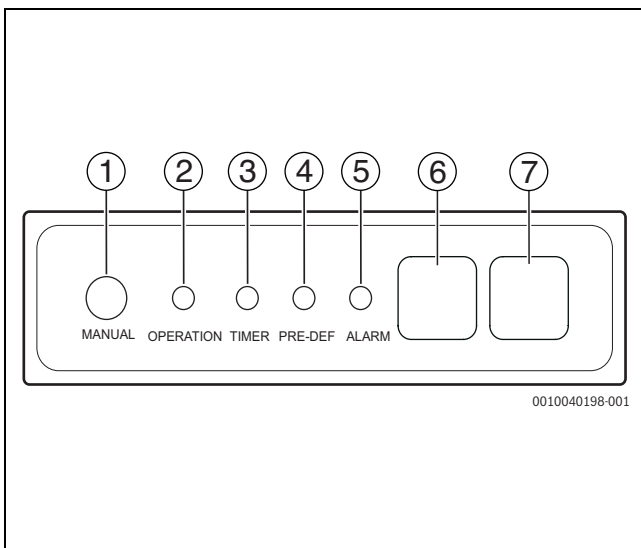

2

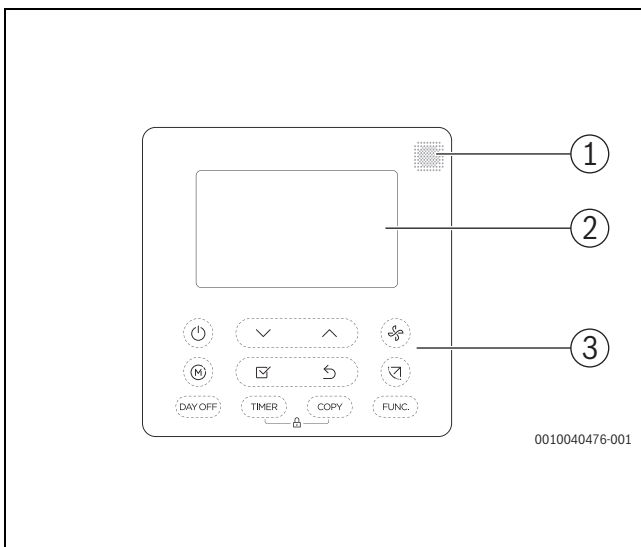

3

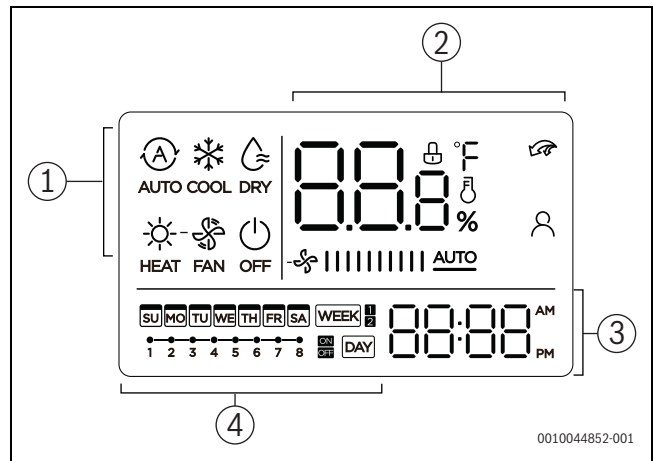

4

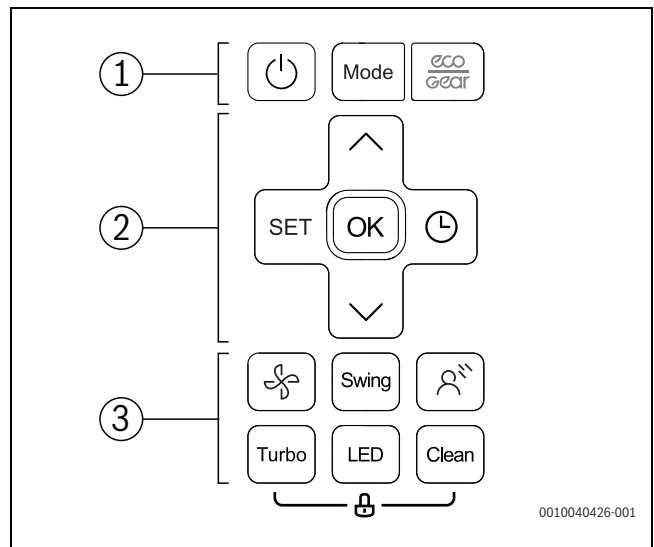

5

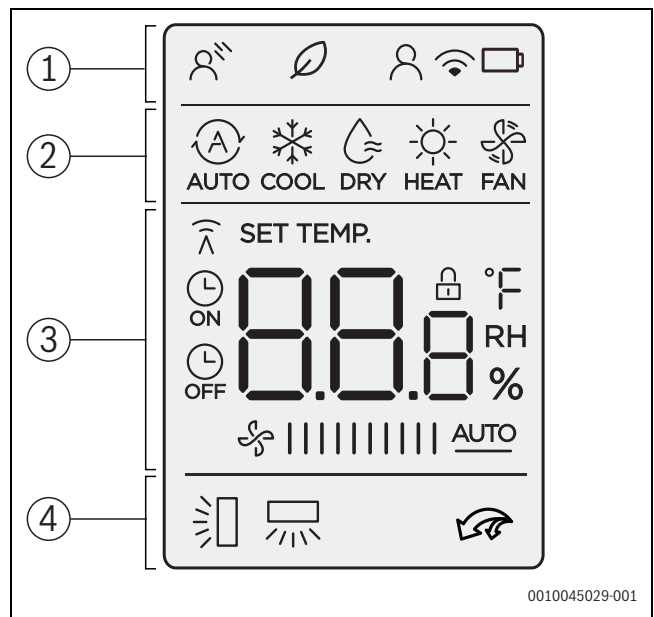

6

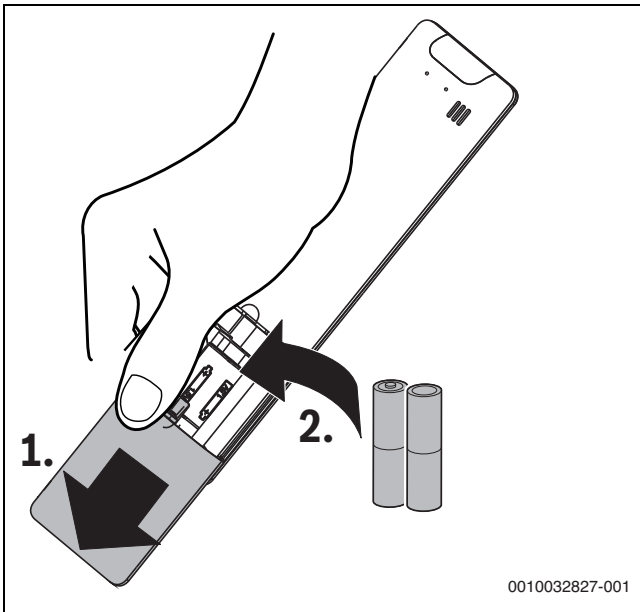

7

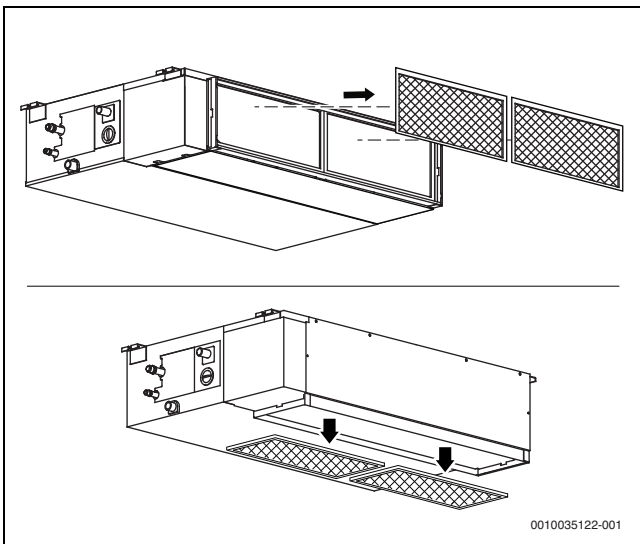

8



Bosch Thermotechnik GmbH  
Junkersstrasse 20-24  
D-73249 Wernau

[www.bosch-thermotechnology.com](http://www.bosch-thermotechnology.com)

