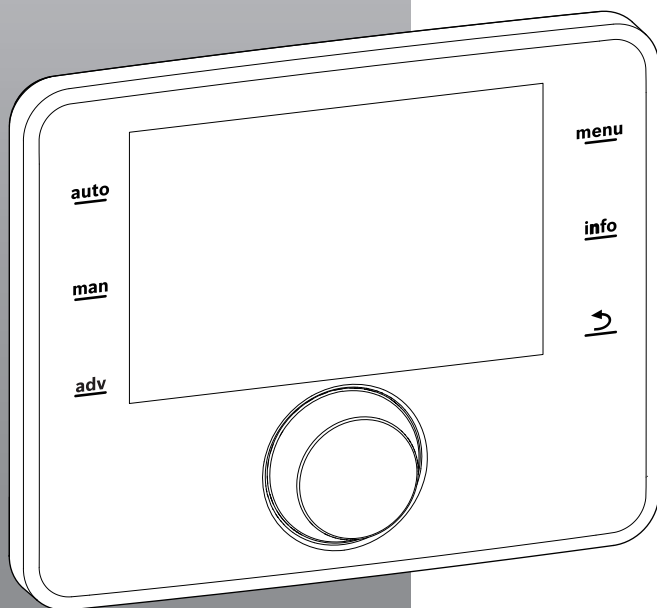


Operating Instructions

Advanced Weather Compensation Controller

Sense II



UK/IE

Contents

1 Key to symbols and safety instructions	3
1.1 Key to symbols	3
1.2 General safety instructions	3
2 Product information	3
2.1 Product data on energy consumption	3
2.2 Range of functions	4
2.3 Function as controller	4
2.4 Applicability of the technical documentation	5
2.5 Declaration of Conformity	5
2.6 Operation after power failure	5
3 Overview of control elements and symbols	5
4 Getting started	9
4.1 Selecting a heating circuit for the standard display	9
4.2 Setting the operating mode	9
4.3 Changing the room temperature	10
4.4 More settings	12
4.5 Activating emergency operation	13
4.6 Activating/deactivating heating and DHW	14
4.7 Bringing forward the switching time	15
5 Working with the main menu	16
5.1 Main menu summary	17
5.2 Heat source settings	18
5.3 Adapting settings for heating system automatic mode	18
5.3.1 Observe with constant heating circuit (e.g. swimming pool or ventilation unit)	19
5.3.2 Adapting Time program for automatic mode	19
5.3.3 Automatic adaptation of the time program	25
5.3.4 Setting summer/winter switchover threshold	25
5.4 Changing the settings for DHW heating	25
5.4.1 Activating DHW heating immediately	26
5.4.2 Setting the DHW temperature	26
5.4.3 Setting the time program for DHW heating	26
5.4.4 Settings for DHW circulation	28
5.4.5 Thermal disinfection	29
5.4.6 Renaming the DHW system	30
5.5 Setting up a holiday program	30
5.6 General settings	33
5.7 Adapting the settings to hybrid systems	34
6 Calling up information about the system	34
7 Energy saving tips	38
8 FAQ	39
9 Eliminate fault	39
9.1 Eliminating "sensed" faults	39
9.2 Removing a displayed fault	41
10 Environment / disposal	43
Technical terms	43
Index	45

1 Key to symbols and safety instructions

1.1 Key to symbols

Warnings



Warnings in this document are identified by a warning triangle printed against a grey background. Keywords at the start of a warning indicate the type and seriousness of the ensuing risk if measures to prevent the risk are not taken.

The following keywords are defined and can be used in this document:

- **NOTICE** indicates a situation that could result in damage to property or equipment.
- **CAUTION** indicates a situation that could result in minor to medium injury.
- **WARNING** indicates a situation that could result in severe injury or death.
- **DANGER** indicates a situation that will result in severe injury or death.

Important information



This symbol indicates important information where there is no risk to people or property.

Additional symbols

Symbol	Explanation
▶	Step in an action sequence
→	Cross-reference to another part of the document
•	List entry
–	List entry (second level)

Table 1

1.2 General safety instructions

These instructions are intended for the user of the heating system

- ▶ Read the instructions (for the boiler, modules etc.) before use and keep them handy.
- ▶ Pay attention to the safety and warning instructions.

Intended use

- ▶ The product should only be used to control heating systems.

All other use is not suitable. We cannot accept liability for damages resulting from unauthorised use.

Inspection and maintenance

Regular inspection and maintenance are prerequisites for safe and efficient operation of the heating system.

- ▶ Have work carried out only by a competent person.
- ▶ If any faults are discovered, have them remedied immediately.

Damage caused by frost

If the system is not in operation it can freeze:

- ▶ Follow the instructions to ensure protection from freezing.
- ▶ Always keep the system switched on for additional functions, such as heating hot water or protection from blockages.
- ▶ Rectify operating faults immediately.

Risk of scalding at the hot water draw-off points

- ▶ If hot water temperatures above 60 °C are set or if thermal disinfection is activated, a mixer must be installed. If in doubt, ask your Installer.

2 Product information

The Sense II controller makes it easy to operate your heating system. Turn the rotary selector to set the required room temperature in your home or building. The thermostatic valves only need to be adjusted if an individual room is too cold or too hot.

Automatic mode with the adjustable time program ensures energy-saving operation by reducing the room temperature at certain times or by shutting down the entire heating system (adjustable reduced temperature). This method of controlling the heating optimises comfort levels whilst minimising energy consumption.

DHW (Domestic Hot Water) heating can be adjusted conveniently and controlled efficiently.

2.1 Product data on energy consumption

The specified product data correspond to the requirements of the EU Regulation No. 811/2013 which supplements ErP Directive 2010/30/EU. The class of the temperature controller is required to calculate the central heating energy efficiency of an integrated system and is for this reason incorporated into the system data sheet.



Sense II function	class ¹⁾	[%] ^{1),2)}	
Sense II			
Room temperature-dependent, modulating	V	3.0	●
Sense II & outside temperature sensor			
Outdoor temperature-dependent, modulating burner	II	2.0	○
Outdoor temperature-dependent, ON/OFF burner	III	1.5	○
Room temperature-dependent, modulating burner	V	3.0	○
Weather-compensated with room temperature influence, modulating burner	VI	4.0	●
Weather-compensated with room temperature influence, ON/OFF burner	VII	3.5	○

Table 2 Product data with regard to energy efficiency of Sense II

- Factory default
- Adjustable
- 1) Classification of the controller according to EU Regulation 811/2013 for the labelling of system packages
- 2) Contribution to seasonal energy efficiency for central heating in %

2.2 Range of functions

These instructions describe the maximum functional scope of the equipment. Your attention is drawn to the importance of the system structure in the relevant places. The settings ranges and basic settings are determined by the individual installation and may deviate from the information provided in these instructions.

For example:

- Settings for a variety of heating circuits are only available if two or more heating circuits are installed.
- Settings for a variety of DHW systems will only be available if two DHW systems are installed (e.g. in an apartment building, where the DHW requirements of the residents can vary greatly).

- Information about additional heating system components (e.g. solar system) are only displayed if the corresponding system components are installed.
- Certain menu settings (e.g. heat source settings) are only available for certain types of heat source or if no cascade module (e.g. MC 400) is installed.

Consult your Installer if you have further questions.

2.3 Function as controller

The Sense II controller can control up to 4 heating circuits. In each heating circuit of the system, the heating controls operate in one of main control modes. Depending on your requirements, your Installer will select and set up one of these modes.



Rule of thumb for room temperature-dependent control and for weather-compensated control with influence of room temperature:
the thermostatic valves in the reference room (the room in which the controller or a remote control is installed) must be fully open!

The main control modes are:

- **Room temperature compensated:**
 - The room temperature is controlled based on the measured room temperature
 - The controller sets the heat output required from the heat source or the flow temperature, technical terms → page 43.
- **Weather compensated:**
 - The room temperature is controlled based on the outside temperature
 - The controller sets the flow temperature in accordance with a simplified or optimised heating curve set up by the installer.
- **Weather compensated with influence of room temperature:**
 - The room temperature is controlled based on the outside temperature and the measured room temperature
 - The controller sets the flow temperature in accordance with a simplified or optimised heating curve set up by the installer.
- **Constant:** Control with constant temperature independent of outside or room temperature, e.g. for swimming pools or ventilation units. Flow temperature can be set in the service menu only by the Installer.

2.4 Applicability of the technical documentation

Information for the heat sources, heating and controllers must also be referenced in conjunction with this document.

2.5 Declaration of Conformity



The design and operation of this product comply with European Directives and the supplementary national requirements. Its conformity is demonstrated by the CE marking .

You can ask for a copy of the declaration of conformity for this product. For this see the contact address on the back cover of these instructions.

2.6 Operation after power failure

In the event of a power failure, or periods with disconnected boiler, no settings are lost. The control unit re-starts when the power returns. It may be necessary to reset the time and date. No other settings are necessary.

3 Overview of control elements and symbols

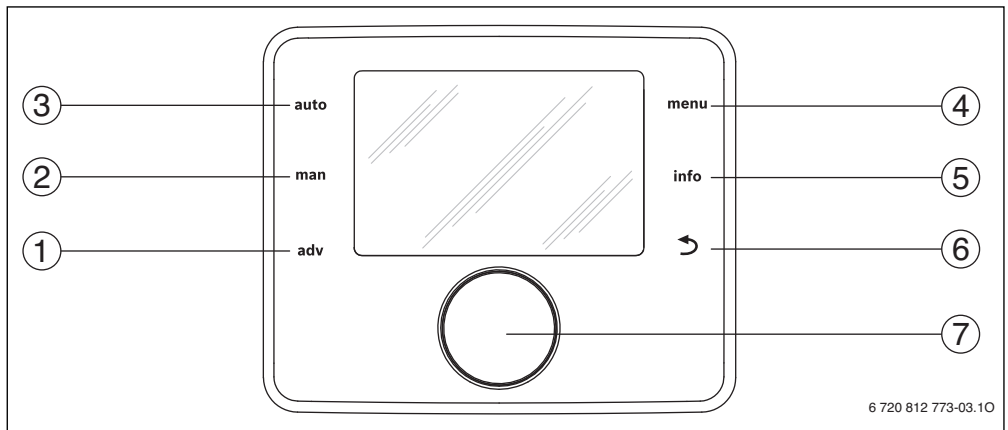


Fig. 1 Control elements

- [1] advance key
- [2] manual key
- [3] auto key
- [4] menu key
- [5] Info key
- [6] Back key
- [7] Selector



The first press of any Key or adjustment of the Selector will only switch on the backlight of the display. The keys/selector must therefore be pressed/adjusted twice to make a change.







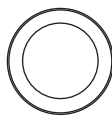
→ Fig. 1, page 5			
Item	Element	Designation	Explanation
1		advance key	<p>If automatic mode with time program is active:</p> <ul style="list-style-type: none"> ▶ Press to bring forward the next switching (heating on) time. <p>If the next switching time has already been brought forward in automatic mode with time program:</p> <ul style="list-style-type: none"> ▶ Press again to undo the change.
2		manual key	<ul style="list-style-type: none"> ▶ Press to activate the manual operation for permanent room temperature set point (continuous operation without time program, → page 9). ▶ Hold down to select the duration of manual operation (maximum approx. 48 hours).
3		auto key	<ul style="list-style-type: none"> ▶ Press to activate the automatic mode with the time program (→ Chapter 4.2, page 9).
4		menu key	<ul style="list-style-type: none"> ▶ Press to open the main menu (→ Chapter 5, page 16).
5		Info key	<p>If a menu is open:</p> <ul style="list-style-type: none"> ▶ Press to call up more information about the current selection. <p>If the standard display is active:</p> <ul style="list-style-type: none"> ▶ Press to open the info menu (→ Chapter 6, page 34).
6		Back key	<ul style="list-style-type: none"> ▶ Press to return to the previous menu level or discard a changed value. <p>If a service or a fault is displayed:</p> <ul style="list-style-type: none"> ▶ Press to switch between standard display and fault/service display. ▶ Hold to switch from a menu to the standard display (home screen).
7		Selector	<ul style="list-style-type: none"> ▶ Turn to change a setting's value (e. g. temperature) or select from among the menus or menu items. <p>If the backlighting is turned off:</p> <ul style="list-style-type: none"> ▶ Press to turn on the backlighting. <p>If the backlighting is turned on:</p> <ul style="list-style-type: none"> ▶ Press to open a selected menu or menu item, confirm a set value (e. g. temperature) or a message or to close a pop-up window. <p>If the standard display is active:</p> <ul style="list-style-type: none"> ▶ Press to select the heating circuit in the standard display (systems with at least two heating circuits only, → Chapter 4.1, page 9).

Table 3 Control elements

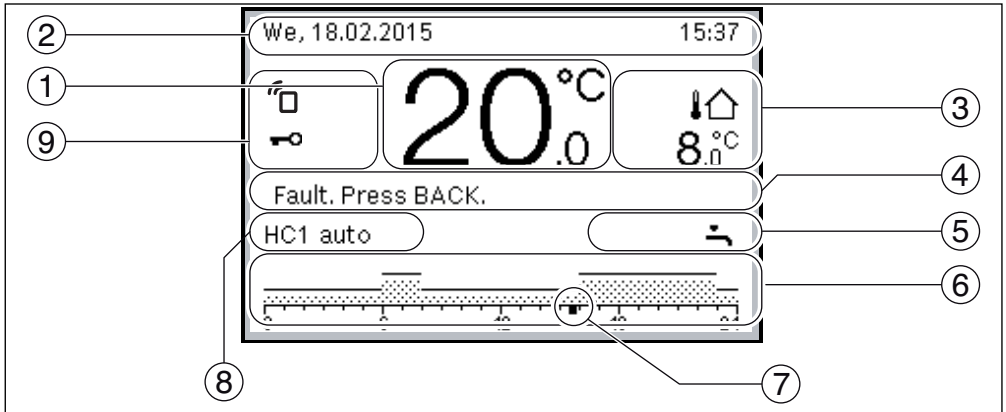


Fig. 2 Example for a standard display of a system with more than one heating circuit

- [1] Value display
- [2] Information line
- [3] Additional temperature display
- [4] Text information
- [5] Information graphic
- [6] Time and temperature program
- [7] Time marker (current time)
- [8] Mode
- [9] Controller status






→ Fig. 2, page 7			
Item	Symbol	Designation	Explanation
1	19.5 °C	Value display	Display of current temperature: <ul style="list-style-type: none"> • Room temperature for wall-mounted installation • Heat source flow temperature for installation in heat source.
2	-	Information line	Display of time of day, day of the week and date.
3	3.0 °C	Additional temperature display	Display of an additional temperature: outside temperature, temperature of the solar collector or a DHW system (for further information → page 33).
4	-	Text information	E.g. the designation of the temperature currently displayed (→ Fig. 2, [1]); a designation for the room temperature is not displayed. If a fault is present, corresponding information will be displayed here until the fault has been rectified.
5	    	Information graphic	Solar pump is in operation DHW heating active. DHW heating is switched off. Burner is on (flame). Heat source is blocked (e.g. by an alternative heat source).

Table 4 Symbols on the standard display

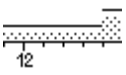








→ Fig. 2, page 7			
Item	Symbol	Designation	Explanation
6		Time and temperature program	Graphical display of the active time program for the heating circuit displayed. The height of the bars represents roughly the desired room temperature in the different time slots.
7		Time marker	The time marker ■ indicates the current time of day in the time program in 15 minute increments.
8		Mode	Heating is completely off (all heating circuits).
			Chimney sweep mode is active.
			Emergency operation is active.
	E		External heat requirement
	auto		System with one heating circuit in automatic mode (heating controlled by time program)
	HC2auto		The displayed heating circuit operates in automatic mode. The standard display refers only to the displayed heating circuit. Pressing the man key, the auto key and changing the required room temperature only affects the heating circuit displayed.
			Heating mode active in automatic mode in the displayed heating circuit
			Setback mode active in automatic mode in the displayed heating circuit
	Summer (off)		System with one heating circuit in summer mode (heating off, DHW heating active, → Chapter 5.3.4, page 25)
	HC2Summer (off)		The displayed heating circuit operates in summer mode (heating off, DHW heating active). The standard display refers only to the displayed heating circuit (→ Chapter 5.3.4, page 25).
	manual		System with one heating circuit in manual operation
	HC2manual		The displayed heating circuit operates in manual operation. The standard display refers only to the displayed heating circuit. Pressing the man key, the auto key and changing the required room temperature only affects the heating circuit displayed.
	Holiday until 10/6/2015		Holiday program active in system with one heating circuit (→ Chapter 5.5, page 30).
HC2Holiday until 10/6/2015	The holiday program is active in the displayed heating circuit and possibly for DHW systems (→ Chapter 5.5, page 30). The standard display refers only to the displayed heating circuit.		
9		Controller status	A communication module is available in the system and a connection to the Worcester server is active.
			The key lock is active (hold down the auto key and the selector to activate or deactivate the key lock).

Table 4 Symbols on the standard display

4 Getting started

An overview of the structure of the main menu and the position of the individual menu items can be found on page 16.

Each of the following descriptions takes the standard display as its starting point (→ page 2, Fig. 7 at left).

4.1 Selecting a heating circuit for the standard display

The standard display only ever shows data for a single heating circuit. If two or more heating circuits are installed, a setting can be made to determine which heating circuit the data in the standard display relates to.

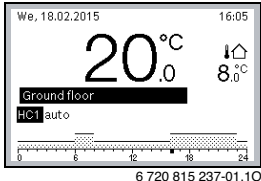
Operating the appliance	Result
<ul style="list-style-type: none"> ▶ If the backlighting is turned on, press the selector. The number, operating mode and if applicable the name of the heating circuit that is currently selected are shown in the lower part of the display. ▶ Turn the selector to select a heating circuit. Only heating circuits that exist in the system are displayed for selection. ▶ Wait a few seconds or press the selector. The standard display refers to the heating circuit selected. <p>Note: Your installer can set the heating circuits that are available in the standard display.</p>	 <p>The image shows a digital display with the date 'We, 18.02.2015' and time '16:05'. The main temperature is '20.0°C'. Below it, 'Ground floor' is highlighted, and 'HC1 auto' is shown. A small house icon with an upward arrow and '8.0°C' is on the right. At the bottom, a bar chart shows a temperature profile over 24 hours, and the number '6 720 815 237-01.10' is at the very bottom.</p>

Table 5 Getting started – Heating circuit in the standard display

4.2 Setting the operating mode

An explanation of the technical terms “operating mode”, “automatic mode” and “manual operation” can be found on page 43 and 44.

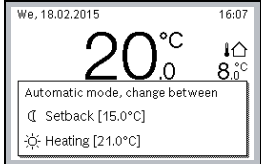
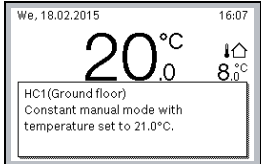
Operating the appliance	Result
<p>To activate automatic mode (by taking account of the time program),</p> <ul style="list-style-type: none"> ▶ Press the auto key. All temperatures set in the currently valid time program for the heating system are shown in a pop-up window in the lower part of the display. The currently valid temperature flashes. The controller controls the room temperature according to the active time program for the heating system. 	 <p>The image shows a digital display with the date 'We, 18.02.2015' and time '16:07'. The main temperature is '20.0°C'. Below it, 'Automatic mode, change between' is shown, with 'Setback [15.0°C]' and 'Heating [21.0°C]' listed. A small house icon with an upward arrow and '8.0°C' is on the right. At the bottom, the number '6 720 815 237-02.10' is displayed.</p>
<p>To activate manual operation (without taking account of the time program),</p> <ul style="list-style-type: none"> ▶ Press the man key. The required room temperature is shown in a pop-up window in the lower part of the display. The controller regulates the room temperature permanently to the required room temperature. <p>Note: If the control type constant is set for a heating circuit (e.g. swimming pool or ventilation unit), there is no manual operation in this heating circuit.</p>	 <p>The image shows a digital display with the date 'We, 18.02.2015' and time '16:07'. The main temperature is '20.0°C'. Below it, 'HC1 (Ground floor)' is shown, followed by 'Constant manual mode with temperature set to 21.0°C'. A small house icon with an upward arrow and '8.0°C' is on the right. At the bottom, the number '6 720 815 237-03.10' is displayed.</p>

Table 6 Getting started – Activating operating modes

4.3 Changing the room temperature



If the control type constant is set for a heating circuit (e.g. swimming pool or ventilation unit), the temperature for this heating circuit can only be set by the Installer. In this case, auto and man keys do not have any function.

Operating the appliance		Result
To check the current required room temperature		
Automatic mode	<ul style="list-style-type: none"> Press the auto key. The room temperature required currently (active operating mode) and the next switching time are shown in a pop-up window in the lower part of the display. 	<p>6 720 815 237-04.1O</p>
Manual operation	<ul style="list-style-type: none"> Press the man key. The required room temperature is shown in a pop-up window in the lower part of the display. If manual operation with restricted duration is active, the required room temperature and the duration of manual operation are displayed. 	<p>6 720 815 237-05.1O</p>
If it is too cold or too warm for you today: Change the room temperature temporarily		
Automatic mode	<p>Bringing forward the room temperature of the next heating on time (switching time)</p> <ul style="list-style-type: none"> Press the adv key to bring forward the room temperature of the next switching time for the time program that is displayed. An adv symbol appears on the display. The change applies until the next switching time in your heating system time program is reached. After this, the time program settings are restored. <p>Undoing the change to the next switching time</p> <ul style="list-style-type: none"> Press the adv key to undo the change to the next switching time. The change is undone. The time program settings are now restored. 	

Table 7 Getting started – Room temperature

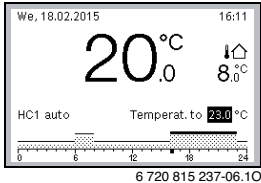
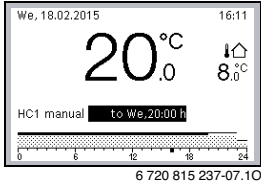
Operating the appliance		Result
Automatic mode	<p>Changing the room temperature until the next switching time</p> <ul style="list-style-type: none"> ▶ Turn the selector to set the required room temperature. The corresponding time slot is displayed in bold in the time program bar chart. ▶ Wait a few seconds or press the selector. The controller operates with the modified setting. The change applies until the next switching time in your heating system time program is reached. After this, the time program settings are restored. 	
	<p>Undoing a temperature change</p> <ul style="list-style-type: none"> ▶ Turn the selector until the corresponding time slot is no longer displayed in bold in the time program bar chart and press the selector <p>-or-</p> <ul style="list-style-type: none"> ▶ <ul style="list-style-type: none"> - Press the man key. - Wait a few seconds or press the selector to close the pop-up window. - Press the auto key. <p>The change is undone.</p>	
Manual operation	<p>Setting a constant room temperature for a limited period of time</p> <ul style="list-style-type: none"> ▶ Press and hold down the man key until the input field for the duration of manual operation is displayed. ▶ Turn the selector to set the required duration. The maximum limited duration for manual operation is approx. 48 hours (2 days) from the current time. ▶ Press the selector. The controller operates with the modified settings. If manual operation ends at the set time, the active time program is restored. 	
	<p>Cancelling limited duration for constant room temperature</p> <ul style="list-style-type: none"> ▶ Set the duration to more than 48 hours (→ setting a constant room temperature for a limited period of time). <p>-or-</p> <ul style="list-style-type: none"> ▶ <ul style="list-style-type: none"> - Activate automatic mode (press auto key). - Wait a few seconds or press the selector to close the pop-up window. - Activate manual operation (press man key). <p>Manual operation is active permanently (constant room temperature for an unrestricted period of time).</p>	

Table 7 Getting started – Room temperature

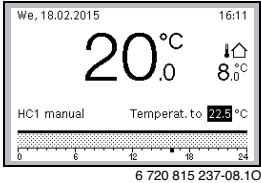
Operating the appliance	Result
If you require a room temperature for a period of time which differs from those in automatic mode: Activate manual operation and set the required room temperature	
<p>Manual operation</p> <ul style="list-style-type: none"> ▶ Press the man key. Manual operation is activated. The room temperature that is currently valid is shown in a pop-up window in the lower part of the display. The time program bar chart is displayed in bold. ▶ Wait a few seconds or press the selector to close the pop-up window. ▶ Turn the selector to set the required room temperature. ▶ Wait a few seconds or press the selector. The room temperature that is currently valid is shown in a pop-up window in the lower part of the display. The controller operates with the modified settings. 	

Table 7 Getting started – Room temperature

4.4 More settings

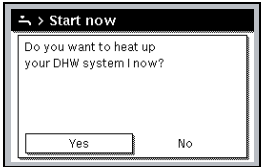
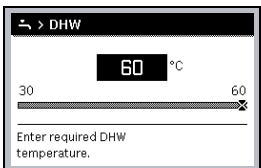
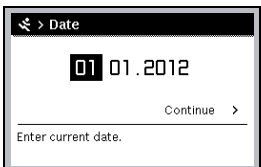
Operating the appliance	Result
If you need hot water outside of the times set in the time program, activate the Heating once setting in the Start now menu (= immediate hot water function).	
<ul style="list-style-type: none"> ▶ Press the menu key to open the main menu. ▶ Turn the selector to highlight DHW. ▶ Press the selector to open the DHW menu. ▶ Press the selector to open the Heating once menu. ▶ Press the selector twice to start the DHW heating. The DHW heating is active immediately for the set duration. Depending on the installed system, it may be necessary to select a DHW system (DHW system I or II). 	
If the DHW is too cold or too hot for you: Change the DHW temperature	
<ul style="list-style-type: none"> ▶ Press the menu key to open the main menu. ▶ Turn the selector to highlight DHW. ▶ Press the selector to open the DHW menu. ▶ Turn the selector to highlight Temperature settings. ▶ Press the selector to open the Temperature settings menu. ▶ Turn the selector to highlight DHW or DHW reduced. ▶ Press the selector. ▶ Turn the selector to set the temperature. ▶ Press the selector. The controller operates with the modified settings. Depending on the installed system, it may be necessary to select a DHW system (DHW system I or II). 	
Setting the date and time	
If the controller has been disconnected from the power supply for a prolonged period, it will prompt the user to enter the date and time and then changes back to normal operation.	
<ul style="list-style-type: none"> ▶ Restore the power supply. The controller displays date settings. ▶ Turn the selector to set the day, month and year. Continue is highlighted in the display. 	

Table 8 Getting started – More settings



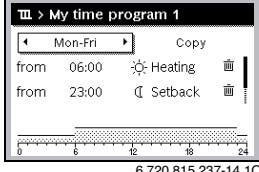
Operating the appliance	Result
<ul style="list-style-type: none"> ▶ Press the selector. ▶ Set the time in the same way as the date. Continue is highlighted in the display. ▶ Press the selector. The controller operates with the modified settings. No other settings are required to recommission the controller. 	
<p>To prevent the settings of the controller from being modified inadvertently: Activate or deactivate key lock (child lock, → page 44)</p>	
<ul style="list-style-type: none"> ▶ Press and hold down the auto key and the selector for a few seconds to activate or deactivate the key lock. When the key lock is enabled, the key symbol appears in the display (→ Fig. 2 [5], page 7). 	
<p>To change the language of the display texts: Set language</p>	
<ul style="list-style-type: none"> ▶ Press the menu key to open the main menu. ▶ Turn the selector to highlight Settings. ▶ Press the selector to open the Settings menu. ▶ Press the selector. ▶ Turn the selector to select a language. ▶ Press the selector. Settings saved 	
<p>If your day/night pattern changes (e.g. if you work shifts): Adapt time program</p>	
<p>In the Heating > Time program menu, the time program can be adapted to suit your personal lifestyle habits or circumstances in just a few easy steps (→ Chapter 5.3.2, page 19).</p>	

Table 8 Getting started – More settings

4.5 Activating emergency operation

It is possible to activate the emergency operation for certain boilers by selecting the heat source menu item from the main menu. In emergency operation the boiler operates its burner

until the flow temperature target has been met. A heat supply for heating and DHW is thus guaranteed in the event of a fault until a competent person has repaired the heating system.

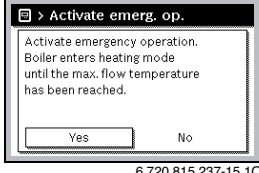
Operating the appliance	Result
<p>Activating emergency operation</p>	
<ul style="list-style-type: none"> ▶ Press the menu key to open the main menu. ▶ Press the selector to open the Heat appliance menu. ▶ Press the selector to select Activate emergency operation. A pop-up window is displayed in the display addressing the question whether you would like to activate the emergency operation. 	

Table 9 Getting started – Emergency operation

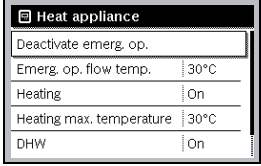
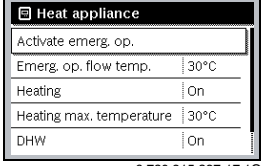
Operating the appliance	Result
<ul style="list-style-type: none"> ▶ If Yes is highlighted, press the selector to activate the emergency operation. The display returns to the Heat appliance menu. ▶ Turn the selector to highlight Emerg. op. flow temp. ▶ Press the selector. ▶ Turn the selector to set the temperature. ▶ Press the selector. <p>The systems operates with the changes settings in emergency operation.</p>	 <p style="text-align: right; font-size: small;">6 720 815 237-16.10</p>
<p>Deactivate emergency operation</p> <ul style="list-style-type: none"> ▶ Press the menu key to open the main menu. ▶ Press the selector to open the Heat appliance menu. ▶ Press the selector to select Deactivate emergency operation. A pop-up window is displayed in the display addressing the question whether you would like to deactivate the emergency operation. ▶ If Yes is highlighted, press the selector to deactivate the emergency operation. The system operates in normal operation again. 	 <p style="text-align: right; font-size: small;">6 720 815 237-17.10</p>

Table 9 Getting started – Emergency operation

4.6 Activating/deactivating heating and DHW

It is possible to activate and deactivate the heating and the DHW for certain types of boiler by selecting the heat source menu item from the main menu. Thus, for example, the system can be controlled manually during a short-term absence of a

few days without the need to set up a holiday program. This function is only available if the system is designed and configured accordingly (e.g. in systems without an MC400 cascade module). The activation/deactivation of the heating is described in Tab. 14. DHW can be operated in the same way.

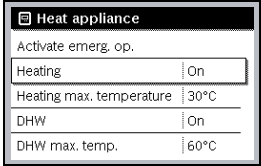
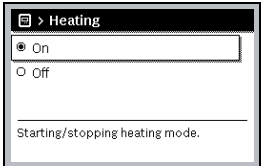
Operating the appliance	Result
<p>Deactivate the heating</p> <ul style="list-style-type: none"> ▶ Press the menu key to open the main menu. ▶ Press the selector to open the Heat appliance menu. ▶ Turn the selector to highlight Heating. ▶ Press the selector to select Heating. ▶ Turn and press the selector to deactivate the heating (Off) or to cancel the selection (On). <p>The changes are effective immediately.</p> <ul style="list-style-type: none"> ▶ Press the Back key to close the menu. 	 <p style="text-align: right; font-size: small;">6 720 815 237-18.10</p>
<p>Activate heating</p> <ul style="list-style-type: none"> ▶ Press the menu key to open the main menu. ▶ Press the selector to open the Heat appliance menu. ▶ Turn the selector to highlight Heating. ▶ Press the selector to select Heating. ▶ Turn and press the selector to activate the heating (On) or to cancel the selection (Off). <p>The changes are effective immediately.</p> <ul style="list-style-type: none"> ▶ Press the Back key to close the menu. 	 <p style="text-align: right; font-size: small;">6 720 815 237-19.10</p>

Table 10 Getting started – Activating/deactivating heating/DHW

4.7 Bringing forward the switching time

The function of the adv key always refers solely to the heating circuit that is active on the standard display.

5 Working with the main menu

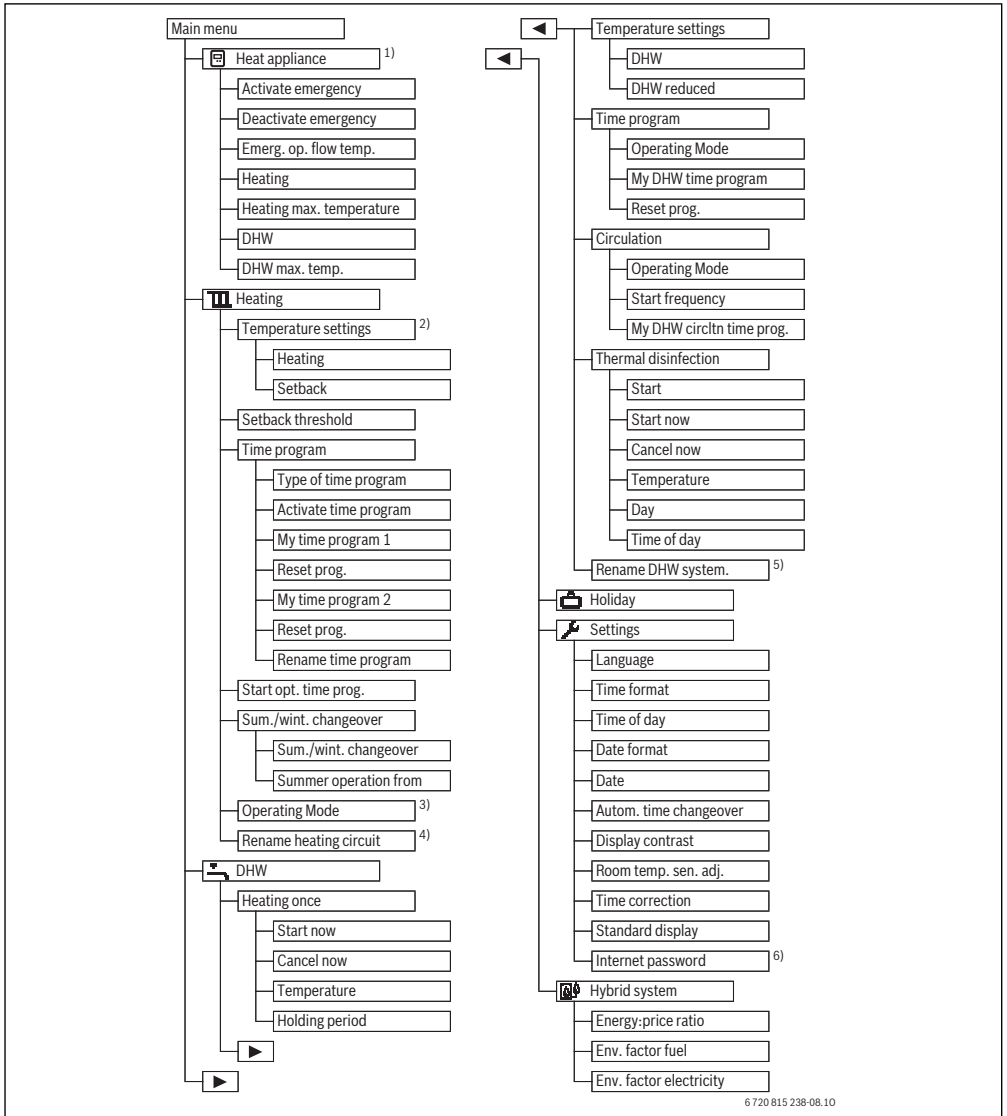


Fig. 3 Menu structure of the main menu

- 1) Only available without cascade module (e.g. MC 400) for certain types of heat source.
- 2) Different levels are only available with type of time program.
- 3) Only available with constant heating circuit.
- 4) Only available with 2 or more heating circuits.
- 5) Only available with 2 DHW systems.
- 6) Only available if an MB LAN2 communication module or an appliance electronics with integrated communication interface (MX 25) is present.

5.1 Main menu summary

If two or more heating circuits or two or more DHW systems are installed in the system, an additional selection must be made in some menus:

- ▶ Turn the selector to select the heating circuit or DHW system for which the settings are being changed.
- ▶ Press the selector to display the menu.







Menu	Purpose of the menu	page
 Heat appliance	Switch heat source to emergency operation. Switch heating and DHW heating in or off and set the maximum flow and DHW temperature. Only available with certain types of heat source if no cascade module (e.g. MC 400) is installed.	18
 Heating	Change the room temperatures and time program for the heating system permanently.	18
Temperature settings/Setback threshold	Set the desired room temperature that can be assigned to the periods in the time program with heating and setback mode or the setback threshold in case of freely adjustable temperatures for switching times.	18
Operating Mode¹⁾	Switch a constant heating circuit on or off and activate a time program of a constant heating circuit (e.g. swimming pool or ventilation unit).	19
Time program	Switch between heating and setback mode or any temperatures at defined times of day and on defined days of the week (automatic mode). Separate time programs can be used for DHW and circulation. Time programs are renamed in this menu.	19
Start opt. time prog.	The time program for the heating system is optimised automatically for increased comfort by bringing forward the switching times. If you do this, the required room temperature will be reached in advance of the switching time. Recommended for high levels of comfort	25
Sum./wint. changeover	Switch automatically between summer mode (heating off) and winter mode (heating on) (subject to outside temperature).	25
Rename heating circuit	Change the name of the heating circuits so that the heating circuits are easier to assign (e.g. heating circuit 1 – ground floor; heating circuit 2 – workshop; heating circuit 3 – swimming pool etc.).	23
 DHW	Change the water temperatures and time program for DHW heating permanently.	25
Heating once	Set temperature and duration for once-only cylinder charging (= immediate DHW heating) and start once-only cylinder charging.	26
Temperature settings	Set water temperatures for different operating modes which can be assigned to the time program.	26
Time program	Switch between DHW, reduced DHW heating and no DHW heating operating modes at defined times of day and on defined days of the week (automatic mode).	26
Circulation	Set time program for DHW circulation so that DHW is available without delay at the draw-off points.	28
Thermal disinfection	Heat up DHW to kill off pathogens.	29
Rename DHW system.²⁾	Change the name of the DHW systems so that they are easier to assign.	23
 Holiday	Settings for operating the system during prolonged periods of absence (holiday program).	30
 Settings	Change general settings such as time, date, display contrast etc.	33
 Hybrid system	If a hybrid system is installed, adapt the settings for its component parts. If a hybrid system is not installed, this menu is hidden disabled.	34

Table 11 Main menu summary

- 1) This menu item is only available if control type Constant is set for a heating circuit.
- 2) This menu item is only available in installations with two DHW systems.

5.2 Heat source settings

This menu is only available for certain types of heat source if the system is designed and configured accordingly (e.g. in systems without cascade module).

Menu: **Heat appliance**

Menu item	description
Activate emergency operation / Deactivate emergency operation	In emergency operation heating and DHW heating are active.
Emerg. op. flow temp.	Set flow temperature in emergency operation
Heating	Switch the heating system on and off.
Heating max. temperature	Maximum flow temperature for heating system
DHW	Switch DHW heating on and off.
DHW max. temp.	Maximum domestic DHW temperature

Table 12 Heat source settings

5.3 Adapting settings for heating system automatic mode

Normally, the time program provides the best heating comfort.

In the default settings for each heating circuit, time program 1 is active with the following settings:

- Starting at 06:00 (08:00 on Saturdays and Sundays) heat to 21 °C (heating mode). Starting at 23:00 heat to 15 °C (setback mode).

These settings provide economic heating from 23:00 in the evening until 06:00 in the morning on the following day.

Heating circuit 1-4

If more than one heating circuit has been installed and configured, the settings for heating circuits 1-4 are changed in the same way as for systems with one heating circuit. However, changes are valid **only for the selected heating circuit**. Assigning unique names to heating circuits makes it much easier to make the right selection.

A Sense I remote control can be installed for each heating circuit. At the Sense I, the required room temperature can be temporarily changed until the next switching point of the time program. After this, the Sense II regains control until the setting at the Sense I is changed again.

Menu: **Heating**

Menu item	description
Temperature settings/ Setback threshold	If the time program with 2 temperature levels is active, the temperatures for the 2 levels Heating and Setback can be set in this menu. If the time program with Freely adjustable temperature is active, the setback threshold is set here. This is the temperature above which the setback mode is activates. (→ Tab. 14, page 19)
Time program	→ Chapter 5.3.2, page 19
Start opt. time prog.	→ Chapter 5.3.3, page 25
Sum./wint. changeover	→ Chapter 5.3.4, page 25
Operating Mode	Only available if the control type Constant is set for the selected heating circuit (→ Chapter 5.3.1, page 19).
Rename heating circuit	The name of the selected heating circuit can be customised here (only available if more than one heating circuit is installed). This helps to select the correct heating circuit, e.g. “underfloor heating system” or “attic apartment”. The names are set by default to Heating circuit 1-4 (→ Tab. 18, page 23).

Table 13 Settings for heating system automatic mode

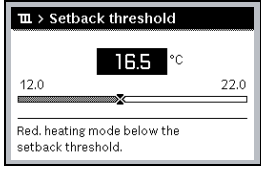
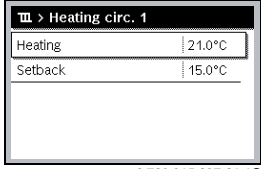
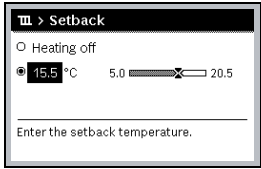
Operating the appliance	Result
<p>Set the required room temperature for heating and setback mode/setback threshold in automatic mode</p> <ul style="list-style-type: none"> ▶ Press the menu key to open the main menu. ▶ Turn the selector to highlight the Heating menu. ▶ Press the selector to open the Heating menu. ▶ If Type of time program is set on Freely adjustable temperature, press the selector to open the Setback threshold menu. ▶ If two or more heating circuits are installed, turn the selector to highlight Heating circuit 1, 2, 3 or 4 and press the selector. ▶ Turn and press the selector to set the temperature. More temperature settings are possible via the time program (→ Chapter 5.3.2, page 19). 	
<ul style="list-style-type: none"> ▶ If Type of time program is set on 2 temperature levels, press the selector to open the Temperature settings menu. <p>Note: The time program can only be set using a App on smartphone or a similar terminal appliance if this setting is selected.</p>	
<ul style="list-style-type: none"> ▶ Turn the selector to highlight Heating or Setback. ▶ Press the selector. ▶ Turn the selector to highlight the desired setting for the setback mode. ▶ Press the selector to activate the selected setting. ▶ Turn and press the selector to set the temperature. The limits of the setting values for the temperatures are determined by the settings for the other operating mode in each case. The controller operates with the modified settings. The settings are applied to all time programs for the heating system (if two or more heating circuits are installed, it is only applied in the selected heating circuit). 	

Table 14 Heating and setback mode/setback threshold for adapting the automatic mode to suit individual preferences

5.3.1 Observe with constant heating circuit (e.g. swimming pool or ventilation unit)

If the control type Constant is set for a heating circuit, the operation deviates from the description in the in the following respects:

- In the **Heating > Operating Mode** menu, the automatic mode is activated for the constant heating circuit (**Auto**) or the control is permanently switched on or off to a constant temperature (**On/Off**).
- The constant heating circuit is heated in the automatic mode by taking account of the time program.
- In the time program, the **On** and **Off** operating modes are available.
- The constant heating circuit is not displayed in the standard display.
- The temperature for the constant heating circuit can be set in the service menu only by a competent person.

5.3.2 Adapting Time program for automatic mode



The time program can only be set using an app on a smartphone or a similar internet connected appliance if the **Type of time program > Levels** setting is selected.

To set the same switching times for multiple days of the week:

- ▶ Set switching times for a group of days, e.g. **Mon-Sun** or **Mon-Fri**.
- ▶ Adjust the time program for the specific days of the week for which different settings are required under **Monday-Sunday** (detailed description → Tab. 17, page 21).

Menu: **Time program**

Menu item	description
Type of time program	There are two ways to set a heating program. Freely adjustable temperatures can be assigned to the individual switching times or the time program switches between two Levels , assigned to the Heating and the Setback operating modes.
Activate time program	Activating automatic mode triggers control of the room temperature according to the settings in the selected time program (My time program 1 or My time program 2).
My time program 1	6 switching times can be set for each day or group of days. One of the two operating modes can be assigned to each switching time in automatic mode. The minimum duration of a time slot between two switching times is 15 minutes.
Reset prog.	Here My time program 1 can be reset to the default settings.

Table 15 Time program settings for heating

Menu item	description
My time program 2	→ My time program 1
Reset prog.	Here My time program 2 can be reset to the default settings.
Rename time program	The names of the time programs can be changed in the same way as the names of the heating circuits. This helps to select the correct time program, e.g. "family" or "night shift".

Table 15 Time program settings for heating

The time program ensures automatic changeover between operating modes at defined switching times. The controller has two time programs for each heating circuit. Up to a maximum of six switching times per day can be programmed, each with a temperature or operating mode. The default settings for the time programs provide economic heating overnight.

If the settings, temperatures or switching times of the time program do not meet your needs, you can adapt the time program.

The following table shows you how to activate and select time programs for the heating system.

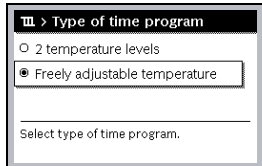
Operating the appliance	Result
<p>Adjust the type of time program</p> <ul style="list-style-type: none"> ▶ Press the menu key to open the main menu. ▶ Turn the selector to highlight Heating. ▶ Press the selector to open the Heating menu. ▶ Turn the selector to highlight the Time program menu. ▶ Press the selector to open the Time program menu. ▶ If two or more heating circuits are installed, turn the selector to highlight Heating circuit 1, 2, 3, 4 and press the selector. ▶ Press the selector. ▶ Turn the selector to highlight the desired setting for Type of time program. ▶ Press the selector to activate the selected setting. 	 <p>6 720 815 237-23.10</p>

Table 16 Activating and selecting time programs for the heating system

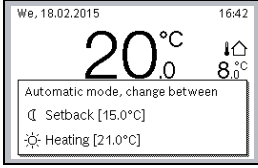
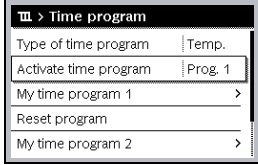
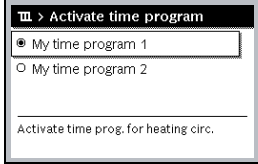
Operating the appliance	Result
Activate time program for the heating system (automatic mode)	
<p>If two or more heating circuits are installed, the heating circuit must be selected before automatic mode is activated (→ Chapter 4.1, page 9).</p> <ul style="list-style-type: none"> ▶ If the standard display is active at manual operation, press the auto key to activate the automatic mode. If a time program of the 2 temperature levels type is active, temperatures for the heating system are shown in a pop-up window in the lower part of the display. The currently valid temperature flashes. ▶ If a time program of the Freely adjustable temperature type is active, automatic mode is shown in a pop-up window in the lower part of the display. 	 <p style="text-align: right;">6 720 815 237-24.10</p>
Select active time program for the heating system	
<ul style="list-style-type: none"> ▶ If the standard display is active, press the menu key briefly to open or close the main menu. ▶ Turn the selector to highlight Heating. ▶ Press the selector to open the Heating menu. ▶ Turn the selector to highlight Time program. ▶ Press the selector to open the Time program menu. ▶ Turn the selector to highlight Activate time program. Depending on the installed system, it may be necessary to select a heating circuit. 	 <p style="text-align: right;">6 720 815 237-25.10</p>
<ul style="list-style-type: none"> ▶ Press the selector. ▶ Turn the selector to highlight My time program 1 or 2 and press the selector. The controller operates in automatic mode with the selected time program (if two or more heating circuits are installed, it only operates in the selected heating circuit). 	 <p style="text-align: right;">6 720 815 237-26.10</p>

Table 16 Activating and selecting time programs for the heating system

The following table shows you how to adapt a time program for the heating system.

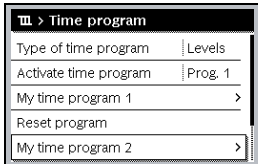
Operating the appliance	Result
Open the menu for adapting a time program for the heating system	
<ul style="list-style-type: none"> ▶ If the standard display is active, press the menu key briefly to open or close the main menu. ▶ Turn the selector to highlight Heating. ▶ Press the selector to open the Heating menu. ▶ Turn the selector to highlight Time program. ▶ Press the selector to open the Time program menu. ▶ Turn the selector to highlight My time program 1 or 2. Depending on the installed system, it may be necessary to select a heating circuit. 	 <p style="text-align: right;">6 720 815 237-27.10</p>

Table 17 Adapting time program to suit individual preferences

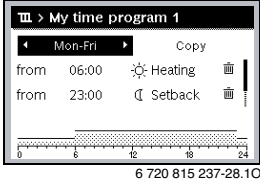
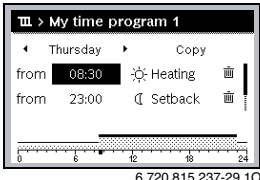
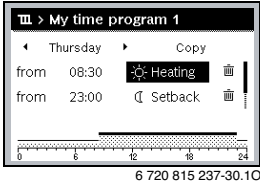
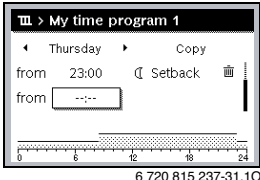
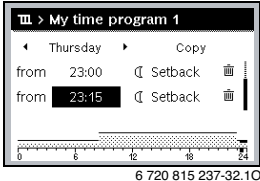
Operating the appliance	Result
<ul style="list-style-type: none"> ▶ Press the selector. ▶ Press the selector again to change the day of the week or the group of days. ▶ Turn the selector to select a day of the week or a group of days and press the selector. The changes in this menu only affect the selected day of the week or the selected group of days. 	
<p>Move switching time</p>	
<ul style="list-style-type: none"> ▶ Open the menu for adapting a time program for the heating system. ▶ Turn the selector to highlight a switching time. ▶ Press the selector to activate the input field for the switching time. ▶ Turn the selector to move the switching time. The modified time slot is displayed in bold in the time program bar chart. ▶ Press the selector. The controller operates with the modified settings. 	
<p>Set the operating mode/temperature for a time slot</p>	
<p>Depending on the type of time program an operating mode or a temperature can be set here for each time slot:</p> <ul style="list-style-type: none"> ▶ Open the menu for adapting a time program for the heating system (→ top). ▶ Turn the selector to highlight the operating mode/temperature setting of a time slot. ▶ Press the selector to activate the input field. ▶ Turn the selector to select an operating mode (heating or setback mode) or to set the temperature. The modified time slot is displayed in bold in the time program bar chart. ▶ Press the selector. The controller operates with the modified settings. 	
<p>Add switching time</p>	
<ul style="list-style-type: none"> ▶ Open the menu for adapting a time program for the heating system (→ page 21). ▶ Turn the selector until the empty input field underneath the last switching time is highlighted. 	
<ul style="list-style-type: none"> ▶ Press the selector. A new switching time is added automatically 15 minutes after the last switching time. This is normally the Off time or Setback period. The input field for the new switching time is enabled. ▶ Turn the selector to set the required time. The new time slot is displayed in bold in the time program bar chart. ▶ Press the selector. The controller operates with the modified settings. 	

Table 17 Adapting time program to suit individual preferences



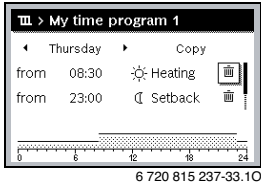
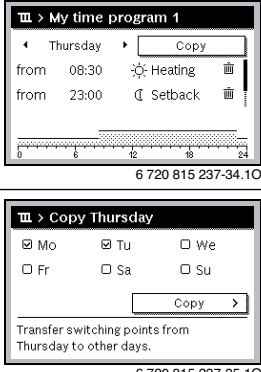
Operating the appliance	Result
<p>Delete switching time (e.g. setback starting at 08:00)</p> <ul style="list-style-type: none"> ▶ Open the menu for adapting a time program for the heating system (→ page 21). ▶ Turn the selector to highlight a symbol for deleting a switching time . The  symbol is associated with the switching time on the same line. ▶ Press the selector. <p>A pop-up window appears prompting you for confirmation.</p> <ul style="list-style-type: none"> ▶ Turn the selector to highlight Yes and press the selector. <p>The switching point is deleted. The previous time slot is extended to the next switching time. The switching times are automatically sorted in chronological order. The controller operates with the modified settings.</p>	
<p>Copy time program (e.g. transfer time program from Thursday to Monday and Tuesday)</p> <ul style="list-style-type: none"> ▶ Open the menu for adapting a time program for the heating system (→ page 21) and select the day of the week to be copied, e.g. Thursday. ▶ Turn the selector to highlight Copy. <p>Press the selector.</p> <p>A list of days of the week for which the time program should be overwritten with the selected day of the week is displayed for you to make a selection.</p> <ul style="list-style-type: none"> ▶ Turn and press the selector to select the day of the week, e.g. Monday and Tuesday. ▶ Turn the selector to highlight Copy and press the selector. ▶ The time program that has been copied is displayed in a pop-up window. ▶ Press the selector to close the pop-up window. <p>The controller operates with the modified settings.</p>	

Table 17 Adapting time program to suit individual preferences

The following table shows you how to change the names of the time programs and the heating circuits.

Operating the appliance	Result
<p>Call up the menu for renaming a time program</p> <ul style="list-style-type: none"> ▶ If the standard display is active, press the menu key briefly to open or close the main menu. ▶ Turn the selector to highlight Heating. ▶ Press the selector to open the Heating menu. ▶ Turn the selector to highlight Time program. ▶ Press the selector to open the Time program menu. ▶ Turn the selector to highlight Rename time program. ▶ Press the selector. <p>The cursor flashes to indicate the start position for data input. The names of the time programs are assigned by default.</p>	

Table 18 Rename heating circuit

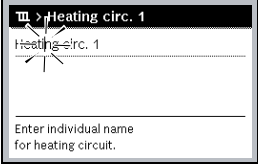
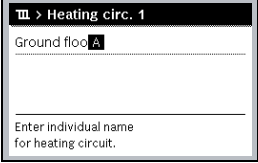
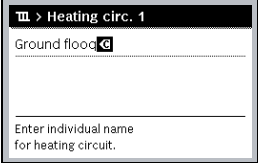
Operating the appliance	Result
<p>Call up the menu for renaming a heating circuit</p> <ul style="list-style-type: none"> ▶ If the standard display is active, press the menu key briefly to open or close the main menu. ▶ Turn the selector to highlight Heating. ▶ Press the selector to open the Heating menu. ▶ Turn the selector to highlight Rename heating circuit (only available if two or more heating circuits are installed). ▶ Press the selector. <p>The cursor flashes to indicate the start position for data input. The names of the heating circuits are assigned by default.</p>	 <p>6 720 815 237-36.10</p>
<p>Enter and insert characters</p> <ul style="list-style-type: none"> ▶ Turn the selector to move the cursor to the position where a character is to be entered. ▶ Press the selector to activate the input field to the right of the cursor. ▶ Turn the selector to select a character. ▶ Press the selector to enter the selected character. <p>The selected character is entered. The input field for the next character in the text is enabled.</p> <ul style="list-style-type: none"> ▶ Turn the selector to enter more characters. ▶ Press the Back key when you have finished making entries. <p>The cursor flashes to the right of the character entered. The controller operates with the modified settings.</p>	 <p>6 720 815 237-37.10</p>
<p>Delete characters/Delete entire name</p> <ul style="list-style-type: none"> ▶ Turn the selector to position the cursor after the letters to be deleted. ▶ Press the selector to activate the input field to the right of the cursor. ▶ Turn the selector until <C is displayed. ▶ Press the selector to delete the character to the left of the enabled input field (<C remains active). ▶ Press the selector again to delete more characters or press the Back key to exit the process. <p>The cursor flashes in the place where the character <C was previously located.</p> <ul style="list-style-type: none"> ▶ Press the Back key to exit the input process and to use the entered name. 	 <p>6 720 815 237-38.10</p>

Table 18 Rename heating circuit

5.3.3 Automatic adaptation of the time program


Menu: **Start opt. time prog.**

Menu item	description
Start opt. time prog. ¹⁾	<ul style="list-style-type: none"> If the cut-in optimisation is switched on, the heating periods in the time program are brought forward so that the set room temperature is reached at the beginning of the heating period. If the cut-in optimisation is switched off, the heating system is switched on at the required times. The set room temperature is reached slightly later.

Table 19 Settings for the cut-in optimisation of the time programs


- 1) Depending on the installed system, it may be necessary to select a heating circuit (heating circuit 1-4).

5.3.4 Setting summer/winter switchover threshold

	<p>NOTICE: System damage</p> <ul style="list-style-type: none"> Do not switch over to summer mode if there is a risk of frost.
--	--

This menu item is only available with weather-compensated control. In order to be able to use weather-compensated control, an outside temperature sensor must be installed.

The heating system is switched off in summer mode, the heating system is switched on in winter mode. DHW heating is independent of the switching between summer and winter modes.

	<p>Switching between summer and winter modes is only active in automatic mode (by taking account of the time program). For constant heating circuits (e.g. for a swimming pool or a ventilation unit) the the switching between summer and winter modes is not available.</p>
---	---

Menu: **Sum./wint. changeover**

Menu item	description
Sum./wint. changeover	<ul style="list-style-type: none"> In summer, heating mode can be switched off (Permanently summer). The heating mode can be shut down based on the outside temperature (Summer mode from); this is only available if the automatic mode is active in the heating circuit. The heating mode can be active constantly (Permanently winter). However, the heat source only goes into operation if it is too cold inside. <p>If more than one heating circuit is installed, instead of the above refer to the individual heating circuit menu.</p>
Summer operation from ¹⁾	<p>If the adjusted outside temperature²⁾ exceeds the temperature threshold set here, the heating system is switched off.</p> <p>If the adjusted outside temperature falls below the temperature threshold set here by 1 °C, the heating system is switched on. In systems with more than one heating circuit, this setting always relates to the corresponding heating circuit in each case.</p>


Table 20 Settings for switching between summer and winter modes

- 1) This menu item is only displayed if the outdoor-temperature-dependent switching between summer and winter modes is active for the heating circuit concerned.
- 2) When the outside temperature is adjusted, changes to the measured outside temperature are delayed and fluctuations reduced.

5.4 Changing the settings for DHW heating

Menu: **DHW**

These settings are only available if at least one DHW system is installed in the system. The water can be heated via a cylinder or according to the instantaneous water heating principle.

	<p>WARNING: Risk of scalding!</p> <p>If thermal disinfection has been activated to avoid legionella, the hot water is heated once to in excess of 65 °C. The factory setting for the hot water temperature is 60 °C. There is a risk of scalding at the draw-off points if the temperature is set higher than this.</p> <ul style="list-style-type: none"> Make sure that a mixer is installed. If in doubt, ask your Installer.
---	--

There is a factory-set custom time program for DHW heating. Alternatively, DHW heating is based on the time programs for heating systems of all heating circuits or it can be constant (→ Chapter 5.4.3, page 26).

DHW system I or DHW system II

If two DHW systems have been installed and configured, the settings can be changed for DHW system I or II in the same way as for installations with one DHW system. However, changes made in the respective menu are valid **only for the selected system**.

5.4.1 Activating DHW heating immediately

If DHW is needed outside the heating periods, DHW heating can be activated manually in this menu.

Menu: **Heating once**

Menu item	description
Start / Cancel now	After activation of the once-only cylinder charging DHW is heated for the set duration to the set temperature. When once-only cylinder charging is active, Start is replaced with Cancel now in the menu. Select this setting for immediate deactivation of the once-only cylinder charging.
Temperature	Desired DHW temperature (15-60 °C ¹) for the once-only cylinder charging
Holding period	Duration for the once-only cylinder charging (15 minutes - 48 hours)

Table 21 Settings for once-only cylinder charging

- 1) Your Installer can only change the maximum value in the service menu for EMS 2 heat sources or DHW heating via MM 100/MM 200 modules.

5.4.2 Setting the DHW temperature

The DHW temperatures for the **DHW** and **DHW reduced** operating modes can be set in this menu.



The temperature setting for the **DHW reduced** operating mode is only available if a DHW cylinder is installed in the DHW system.

Menu: **Temperature settings**

Menu item	description
DHW	Desired DHW temperature (15-60 °C ¹) for the DHW operating mode. If automatic mode is active, the DHW time program will switch to this temperature at the start of every heating phase for which corresponding settings have been made. This temperature cannot be set lower than the temperature for DHW reduced .
DHW reduced	Required DHW temperature for DHW reduced operating mode. If automatic mode is active, the time program will switch to this temperature at the start of every heating phase for which corresponding settings have been made.

Table 22 Temperature settings for DHW

- 1) Your Installer can change the maximum value in the service menu.

5.4.3 Setting the time program for DHW heating

The time program for DHW heating can be adjusted in this menu.



If a DHW system without a DHW cylinder is installed (DHW heating with a combi heater), only the **On** and **Off** operating modes will be available in the time program. If **Off** operating mode is active, the keep hot function is off. Consequently, hot water will only be available after running the hot tap for a while.

Linking the time program for DHW to the time program for the heating system

In the default settings, DHW is heated based on a separate time program.

- If **Own time program** is set, the **DHW** operating mode is active daily from 05:00 (from 07:00 on Saturdays and Sundays) until 23:00 (time program default settings). If DHW heating is via a combi boiler, the keep hot function is active at the same times. In both cases the keep hot function is switched off during the night.
- If **As heating circuit time program** is set, DHW heating is active in the **DHW** operating mode for half an hour before, during and after each heating phase of all heating circuits.

Menu: **Time program**

Menu item	description
Operating Mode	<ul style="list-style-type: none"> DHW heating can be linked to the time program for the heating system (As heating circuit time program, → page 26). You can use the Own time program to set a time program for DHW heating that works independently of the time program for the heating system. If Always on - DHW red. or Always on - DHW is set, the DHW heating is active constantly. In case of Off there is no DHW heating/keep hot.

Table 23 Time program settings for DHW

Menu item	description
My DHW time program	6 switching times can be set for each day or group of days. One of up to three operating modes can be assigned to each switching time in automatic mode. The minimum duration of a time slot between two switching times is 15 minutes.
Reset prog.	The time program for the DHW system is reset to the default settings with this menu item.

Table 23 Time program settings for DHW

The following table shows you how to adapt the settings for DHW heating.

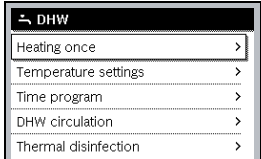
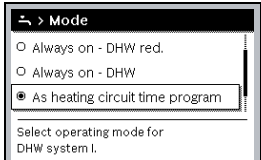
Operating the appliance	Result
Open the menu for the DHW settings	
<ul style="list-style-type: none"> ▶ If the standard display is active, press the menu key briefly to open or close the main menu. ▶ Turn the selector to highlight DHW. ▶ Press the selector to open the DHW menu. 	 <p>6 720 815 237-39.10</p>
Selecting and setting the time program for DHW heating	
<ul style="list-style-type: none"> ▶ Open the menu for the DHW settings. ▶ Turn the selector to highlight Time program. ▶ Press the selector to open the Time program menu. ▶ Press the selector to open the Operating Mode menu. ▶ Turn the selector to select As heating circuit time program and press the selector. The time program for the heating system now also determines the switching times of the time program for DHW heating (→ Chapter 5.4.3, page 26). Depending on the installed system, it may be necessary to select a DHW system. 	 <p>6 720 815 237-40.10</p>

Table 24 Adapting the settings for DHW heating

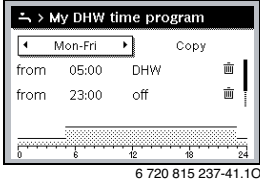
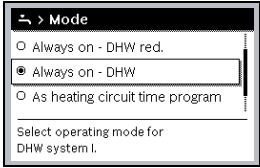
Operating the appliance	Result
<p>▶ Turn the selector to mark the Own time program menu item and press the selector. The time program for hot water is independent of the time program for the heating system. The switching times can be set separately in the Time program > My DHW time program menu (operation as described in Chapter 5.3.2 starting on page 19). The DHW temperatures set for the operating modes are valid in the time slots.</p>	
Activate constant DHW heating	
<p>▶ Open the menu for the DHW settings.</p> <p>▶ Turn the selector to highlight the Time program menu item.</p> <p>▶ Press the selector to open the Time program menu.</p> <p>▶ Press the selector to open the Operating Mode menu.</p> <p>▶ Turn the selector to highlight Always on - DHW red. or Always on - DHW.</p> <p>▶ Press the selector.</p> <p>DHW heating is set to constant. Depending on the installed system, it may be necessary to select a DHW system.</p>	

Table 24 Adapting the settings for DHW heating

5.4.4 Settings for DHW circulation

A DHW circulation pump circulates DHW between the DHW heater and the draw-off point (e.g. water tap). This makes DHW available at the draw-off point more quickly. Settings can be made determining when and how often the DHW circulation pump is activated.

This menu is only available for systems with DHW circulation pump.

Menu: **Circulation**

Menu item	description
<p>Operating Mode</p>	<ul style="list-style-type: none"> • Circulation can be switched off permanently (Off). If this setting is set to On, the pump will run according to the settings under Start frequency. The time program for the DHW circulation pump is not active. • The circulation can be linked to the time program for DHW heating (As DHW system I or II). • With Own time program a time program for the DHW circulation pump can be set that works independently of the time program for DHW.

Table 25 Settings for the circulation

Menu item	description
<p>Start frequency</p>	<p>The start frequency determines how often the DHW circulation pump goes into operation for three minutes at a time every hour (1 x 3 minutes/h - 6 x 3 minutes/h) or if it is constantly in operation. Whatever the case, circulation is only active during the times set in the time program.</p>
<p>My DHW circftrn time prog.</p>	<p>6 switching times can be set for each day or group of days. The DHW circulation pump can be switched on or off at each switching time. The minimum duration of a time slot between two switching times is 15 minutes.</p>

Table 25 Settings for the circulation

The following table shows you how to adapt the settings for DHW circulation.

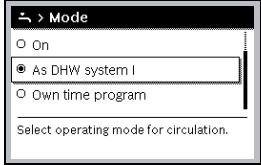
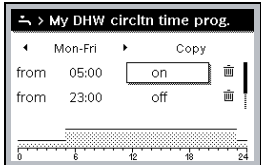
Operating the appliance	Result
<ul style="list-style-type: none"> ▶ Open the menu for the DHW settings (→ page 27). ▶ Turn the selector to highlight Circulation. ▶ Press the selector to open the Circulation menu. The Operating Mode menu item is highlighted. ▶ Press the selector. ▶ Turn the selector to highlight As DHW system I or II and press the selector. The controller operates with the modified settings. The DHW circulation pump is only in operation when DHW heating is active. Depending on the installed system, it may be necessary to select a DHW system. 	 <p style="text-align: right; font-size: small;">6 720 815 237-43.10</p>
<ul style="list-style-type: none"> ▶ Turn the selector to highlight Own time program and press the selector. The time program for circulation is independent of the time program for DHW heating. The switching times can be set separately in the Circulation > My circulation time program menu (operation as described in Chapter 5.3.2 starting on page 19). The circulation is either switched on or off in the respective time slots. 	 <p style="text-align: right; font-size: small;">6 720 815 237-44.10</p>
<ul style="list-style-type: none"> ▶ Turn the selector to highlight Off or On and press the selector. The controller operates with the modified settings. The DHW circulation pump is always off in the phases with Off. 	

Table 26 Settings for Adapt circulation

5.4.5 Thermal disinfection

Following thermal disinfection, the cylinder content slowly cools back down to the set DHW temperature. Consequently, the DHW temperature may briefly be higher than the selected temperature.



CAUTION: Legionnaire's bacteria constitute a health hazard!

- ▶ At low hot water temperatures thermal disinfection or daily heating should be activated¹⁾.

- 1) Daily heating can be set by your installer in the service menu.



If the thermal disinfection is set and activated at the heat source, the settings at the controller have no effect on the thermal disinfection.



WARNING: Risk of scalding!

If thermal disinfection has been activated to avoid legionella, the hot water is heated once to in excess of 65 °C (e.g. Thursday night at 02:00).

- ▶ Only schedule thermal disinfection for periods outside normal usage times.
- ▶ Make sure that a mixer is installed. If in doubt, ask your Installer.

The thermal disinfection safeguards the hygienic quality of the DHW. The hot water is heated regularly to the set temperature. This also kills off legionella, for example. Thermal disinfection can be configured in this menu.

If a DHW cylinder is connected downstream of the low loss header, it might not be possible to reach the temperature necessary for thermal disinfection. For more information, consult your Installer.

This menu is only available for DHW systems with DHW cylinder.

Menu: **Thermal disinfection**

Menu item	description
Start	The entire DHW volume is only heated to the set temperature once a week or once a day if Auto is set here.
Start / Cancel now	Immediate start or termination of the thermal disinfection independent from the set day of the week
Temperature	Temperature of the entire DHW volume at thermal disinfection (65-80 °C)
Day	Day of the week on which the thermal disinfection is automatically carried out once a week or daily thermal disinfection
Time of day	Time of day for the automatic start of thermal disinfection

Table 27 Settings for the thermal disinfection

5.4.6 Renaming the DHW system¹⁾

Menu: **Rename DHW system.**

In this menu the designation of the DHW systems can be adapted so that they are easier to assign. The name of the selected system can be changed in the same way as the names of the heating circuits (→ Tab. 18, page 23). This helps to select the correct DHW system.

5.5 Setting up a holiday program

Menu: **Holiday**

If you leave the house for several days, or if you stay at home for your holidays for several days, you can set the holiday program. You can optionally switch off DHW heating completely for the duration of your holiday. The factory settings ensure energy efficient and reliable operation during your holiday. During the holiday period, the display indicates when the holiday program will be active until.

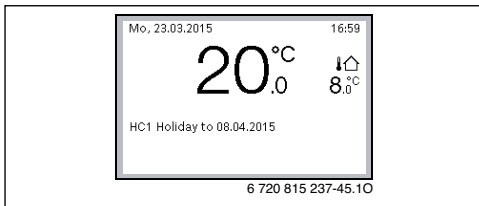


Fig. 4 Standard display during holiday period

When the holiday period elapses, all settings are restored to everyday settings.

1) This menu is only available in installations with two DHW systems.

NOTICE: System damage!

- ▶ Before a prolonged period of absence, only change the settings under **Holiday**.
- ▶ After a long absence, check the operating pressure of the heating system and check the pressure gauge on the solar pump station if applicable.
- ▶ Do not switch off the solar system during long absences.

A detailed description of how you can set the holiday program can be found in Tab. 29, starting on page 32.

If control type Constant is set for a heating circuit, a holiday program is not available for this heating circuit.

Menu: **Holiday 1, Holiday 2, Holiday 3, Holiday 4 and Holiday 5**

Menu item	description
Holiday period	Set the start and end date of the absence during holiday: The holiday program is started at the set beginning at 00:00. The holiday program is terminated at the set end at 24:00.
Selection heat. circ./ DHW	The holiday program is applied to the sections of the system highlighted here. Only the heating circuits and DHW systems actually installed in the system are listed for selection.

Table 28 Settings for holiday programs

Menu item	description
Heating	<p>Control of the room temperature for the selected heating circuits during the holiday period:</p> <ul style="list-style-type: none"> • With As Saturday, the heating system runs in the selected heating circuits every day in accordance with the time program that is active for Saturday (holiday at home). • A Constant temperature can be selected and will be valid for the entire holiday period for the selected heating circuits. • The Off setting deactivates the heating system completely for the selected heating circuits. • With the Setback setting, the heating system runs in the selected heating circuits in the operating mode set by the Installer in each case (Reduced mode, Outside temperature threshold, Room temperature threshold starting on page 39).
DHW	<p>DHW settings for the selected DHW systems during the holiday period.</p> <ul style="list-style-type: none"> • If Off is set, no DHW at all will be available during the holiday period. • If Off + therm. disinfection on is set, DHW heating is deactivated but thermal disinfection is still carried out as normal either once a week or one a day. <p>Note: If the holiday is spent at home, so that DHW remains available, the DHW systems must not be selected under Selection heat. circ./DHW.</p>
Delete	Delete all settings for the selected holiday program

Table 28 Settings for holiday programs

The following table shows you how to set up a holiday program, interrupt a holiday program that is active and delete a holiday program. The holiday program starts on the set date only in heating circuits in which automatic mode is active.

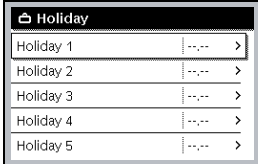
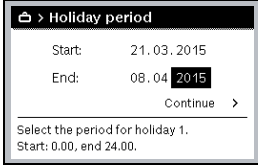
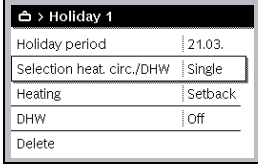
Operating the appliance	Result
<p>Open the menu for the holiday program</p> <ul style="list-style-type: none"> ▶ If the standard display is active, press the menu key briefly to open or close the main menu. ▶ Turn the selector to highlight Holiday. ▶ Press the selector to open the Holiday menu. ▶ Turn the selector to highlight Holiday 1, 2, 3, 4 or 5. If the period of time has been set for a holiday program, the start date is displayed in the menu. ▶ Press the selector. If the period of time has already been set for the holiday program, the Holiday 1, 2, 3, 4 or 5 menu is displayed. If the period of time for the holiday program has not been set, the start date and end date for the holiday program must be set. After this, the Holiday 1, 2, 3, 4 or 5, menu is displayed. 	 <p style="text-align: right; font-size: small;">6 720 815 237-46.10</p>
<p>Set the holiday time</p> <ul style="list-style-type: none"> ▶ Open the menu for the holiday program. The menu item for entering the start and end date of the holiday period opens. The input field for entering the start day is highlighted. ▶ Turn the selector to highlight the day, months or year for the start or end date and press the selector. The selected field is enabled for input. If the holiday time has not yet been entered, today's date is set as the start date. The end date is a week after the start date. ▶ Turn the selector to set the day, month or year for the start or the end date and press the selector. ▶ Once the holiday time has been set, turn the selector to highlight Continue and press the selector. If the display switches to the higher menu level, the controller is operating with the modified settings. If the controller does not switch to the higher menu level, follow the instructions on the display. 	 <p style="text-align: right; font-size: small;">6 720 815 237-47.10</p>
<p>Select and set the heating circuit and DHW system for the holiday program</p> <ul style="list-style-type: none"> ▶ Open the menu for the holiday program. ▶ Turn the selector to highlight Selection heat. circ./DHW. 	 <p style="text-align: right; font-size: small;">6 720 815 237-48.10</p>

Table 29 Setting up, interrupting or deleting a holiday program

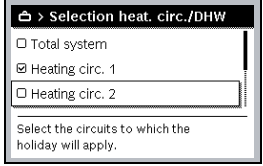
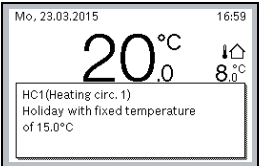
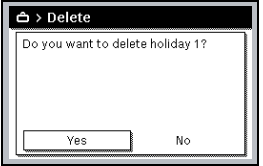
Operating the appliance	Result
<ul style="list-style-type: none"> ▶ Press the selector to open the Selection heat. circ./DHW menu. If Total system is selected, all parts of the system are highlighted. ▶ Turn the selector to highlight a heating circuit or a DHW system. ▶ Press the selector. ▶ The selection for the heating circuit or DHW system is undone. Press the selector again to select the heating circuit or the DHW system again. Undoing the selection of a heating circuit or DHW system also automatically undoes the selection of the entire system. ▶ Turn the selector to highlight Continue and press the selector. The controller operates with the modified settings. ▶ Check the settings for heating and DHW and make any necessary adjustments (→ Chapter 5.5, page 30). 	
<p>Interrupt a holiday program</p> <p>During the holiday period, the display indicates when the holiday program will be active until. If two or more heating circuits are installed, the heating circuit must be selected before interrupting the holiday program (→ Chapter 4.1, page 9).</p> <ul style="list-style-type: none"> ▶ Press the man key. Manual operation is activated. The room temperature that is currently valid is shown in a pop-up window in the lower part of the display. ▶ Change the required room temperature, if necessary. ▶ Press the auto key to reactivate the holiday program. <p>If the holiday program is set to As Saturday, you can also interrupt the holiday program by turning the selector. The change is effective until the active time program reaches the next switching time. The holiday program applies again from this switching time onwards.</p>	
<p>Delete the holiday program, e.g. to bring it to an end early</p> <ul style="list-style-type: none"> ▶ Open the menu for the holiday program (→ page 32). ▶ Turn the selector to mark the Delete menu item and press the selector. A pop-up window appears in the display prompting you to confirm whether the selected holiday program is to be deleted. ▶ Turn the selector to highlight Yes and press the selector. ▶ A message is displayed in a pop-up window indicating which holiday program has been deleted. ▶ Press the selector. The holiday program is deleted. 	

Table 29 Setting up, interrupting or deleting a holiday program

5.6 General settings

No settings are lost in the event of a brief power failure or if the heat source is shut down for short periods of time. When the power supply is restored, the controller resumes operation. If the shutdown period is prolonged, the settings for the time of day and the date may have to be reset. No other settings are required (Tab. 8, page 12).

Menu: Settings

Menu item	description
Language	Language of the display texts
Time format	Switch the format for display of the time of day between 24-hour and 12-hour format.
Time of day	All time programs and thermal disinfection run according to this time. The time of the day can be set in this menu.
Date format	Change the format of the date.

Table 30 General settings

Menu item	description
Date	The holiday program, for example, runs according to this date. The current date of the week is also determined based on this date; this affects the time programs and thermal disinfection, for example. The date can be set in this menu.
Autom. time changeover	Activate or deactivate the automatic changeover between summer and winter time. If Yes is set, the time of day is automatically changed (from 02:00 to 03:00 on the last Sunday in March and from 03:00 to 02:00 on the last Sunday in October).
Display contrast	Change the contrast (for a clearer display)
Room temp. sen. adj.	Correction of the room temperature displayed by the controller by up to ± 3 °C (→ Calibrate room temperature sensor (Room temp. sen. adj.), page 34).
Time correction	Time correction of the controller's internal clock in s/week (→ Set correct time correction (Time correction), page 34)
Standard display	Settings for the display of additional temperatures in the standard display
Internet password	Reset the personal password for the Internet connection (only available if a MB LAN2 communication module or an MX 25 appliance electronics with integrated communication module is installed). The next time you log in, e.g. using an App you will automatically be prompted to assign a new password.

Table 30 General settings

Calibrate room temperature sensor (Room temp. sen. adj.)

- ▶ Locate a suitable thermometer close to the controller so that they are both subject to the same heat influences.
- ▶ Keep heat sources such as direct sunlight and body heat, etc., away from the controller and the thermometer for one hour.
- ▶ Open the menu for sensor calibration.
- ▶ Turn the selector to set the correction value for the room temperature. For example, if the thermometer is showing a temperature 0.7 °C higher than the controller, increase the setting value by 0.7 K.
- ▶ Press the selector.
The controller operates with the modified settings.

Set correct time correction (Time correction)

Example of calculation of the value for time correction with a deviation of approx. – 6 minutes per year (the control unit clock runs 6 minutes late):

- – 6 minutes per year = – 360 seconds per year
- 1 year = 52 weeks
- – 360 seconds: 52 weeks = – 6.92 seconds per week
- Increase time correction to 7 seconds per week.

5.7 Adapting the settings to hybrid systems

Menu: Hybrid system

In an installation with a hybrid system, there are two different heat sources. One renewable energy heat source, i.e. geothermal, solar or biomass energy, and, in addition, a conventional heat source providing heat generated from oil, gas or electricity.

If a hybrid system or a hybrid appliance is installed, the **Hybrid system** menu is displayed. Depending on which hybrid system or hybrid appliance is being used and the associated assemblies or components, various settings can be made. For more information, see the technical documentation for the hybrid system or hybrid appliance (e.g. ODU 75 WPLSH).

6 Calling up information about the system

The current system values and the active operating conditions can be displayed easily via the info menu. No changes can be made in this menu.

The info menu is adapted to your system automatically. Some menu items are only available if the system has been set up accordingly and the controller has been set correctly (→ Chapter 2.2, page 4).

- ▶ If the standard display is active, press the info key to open the info menu.
- ▶ Turn the selector to select the required menu, e.g. **DHW**.
- ▶ Press the selector to open the selected menu.
- ▶ Turn the selector to display more available information.
- ▶ Press the Back key to return to the previous menu level.
- ▶ Press and hold the Back key to return to the standard display.

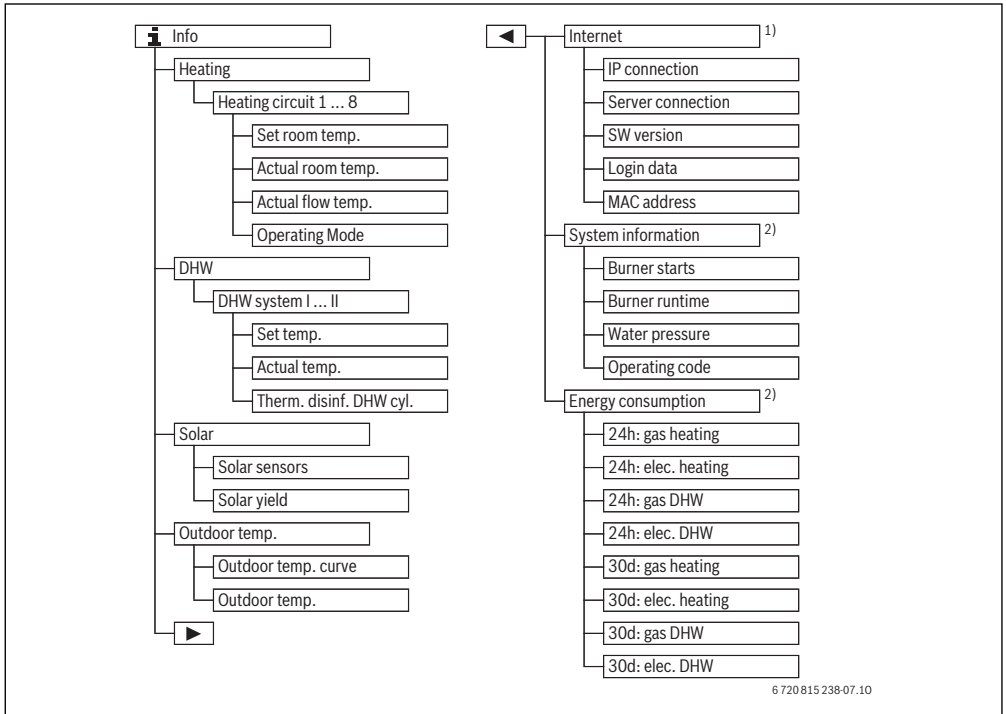


Fig. 5 Menu structure of the info menu

- 1) Only available if an MB LAN2 communication module or an appliance electronics with integrated communication interface (MX 25) is present.
- 2) Only available without cascade module (e.g. MC 400) for certain types of heat source.

Menu: Heating

The menu items in this menu are only available for installed heating circuits.

Menu item	description
Set room temp.	The desired room temperature that is currently valid in the selected heating circuit: <ul style="list-style-type: none"> • In automatic mode, the desired room temperature can change several times a day, if necessary. • In manual operation, it is permanently constant
Actual room temp.	Currently measured room temperature in the selected heating circuit
Actual flow temp.	Currently measured flow temperature in the selected heating circuit
Operating Mode	Currently valid operating mode in the selected heating circuit (Off, Heating, Setback, Summer, Holiday or Manual)

Table 31 Information about the heating

Calling up information about the system

Menu: **DHW**

This menu is only available if at least one DHW system is installed.

Menu item	description
Set temp.	Desired DHW temperature in the selected DHW system
Actual temp.	Currently measured DHW temperature in the selected DHW system
Therm. disinf. DHW cyl.	Thermal disinfection of the DHW activated or deactivated

Table 32 Information about DHW

Menu: **Solar**

This menu is only available if at least one solar system is installed. Information is only displayed under the individual menu items if the corresponding parts of the system are installed.

Menu item	description
Solar sensors (graphics)	Currently measured temperatures with display of the position of the selected temperature sensor in the solar system hydraulics (with graphical visualisation of the current operating conditions of the actuators in the solar system)
Solar yield	Solar yield for last week, solar yield for current week and total yield of solar system since the solar system was commissioned

Table 33 Information about the solar system

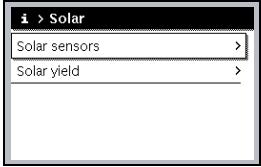
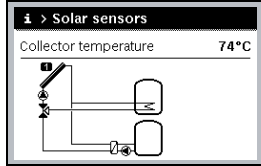
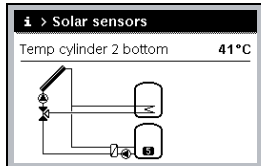
Operating the appliance	Result
<p>Call up information about the solar system</p> <ul style="list-style-type: none"> ▶ If the standard display is active, press the info key to open the info menu. ▶ Turn the selector to highlight Solar. ▶ Press the selector to open the Solar menu. 	 <p>6 720 815 237-52.10</p>
<ul style="list-style-type: none"> ▶ Turn the selector to mark the Solar sensors menu item and press the selector. The current temperature at the temperature sensor with the lowest number is displayed. The number in the graphic indicates the position of the temperature sensor in the system, e.g. collector temperature [1]. 	 <p>6 720 815 237-53.10</p>
<ul style="list-style-type: none"> ▶ Turn the selector to call up more temperatures. The graphics in the info menu in the solar system show the installed pumps, mixers and valves. When a pump is running the symbol for the pump is rotating. Solid triangles in the symbols for mixers or valves indicate the direction in which the heat transfer fluid is flowing. 	 <p>6 720 815 237-54.10</p>

Table 34 Call up information about the solar system

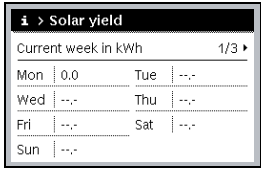
Operating the appliance	Result
Information about solar yield	
<ul style="list-style-type: none"> ▶ If the standard display is active, press the info key to open the info menu. ▶ Turn the selector to highlight Solar. ▶ Press the selector to open the Solar menu. ▶ Turn the selector to highlight Solar yield and press the selector. The solar yields for the current week are displayed. ▶ Turn the selector to switch the display between solar yield for the current week, solar yield for last week and total yield of solar system since commissioning. 	 <p>6 720 815 237-55.10</p>

Table 34 Call up information about the solar system

Menu item: **Outdoor temp.**

This menu is only displayed if an outside temperature sensor is installed.

The currently measured outside temperature is displayed in this menu. In addition, a diagram of the outside temperature profile for today and yesterday (from 00:00 to 24:00 in each case) is displayed here.

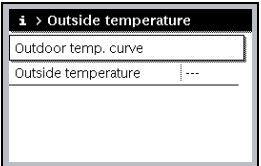
Operating the appliance	Result
Calling up the outside temperature profile	
<ul style="list-style-type: none"> ▶ If the standard display is active, press the info key to open the info menu. ▶ Turn the selector to highlight Outdoor temp. and press the selector. ▶ Press the selector. The diagram shows the outside temperature profile for the last 2 days (more detailed information, → Chapter 6, page 34). 	 <p>6 720 815 237-56.10</p>

Table 35 Information about the outside temperature call up

Menu: **Internet**

This menu is only available if at least one communication module is installed.

Menu item	description
IP connection	Status of the connection between communication module and router
Server connection	Status of the connection between communication module and Internet (via the router)
SW version	Software version of the communication module
Login data	Login name and password for the login into the App to operate the system via a smartphone
MAC address	MAC address of the communication module

Table 36 Information about the Internet connection

Menu: **System information**

This menu is only available if no cascade module (e.g. MC 400) is installed. Information is only displayed under the individual menu items if the corresponding parts of the system are installed.

Menu item	description
Burner starts	Number of burner starts since the system was commissioned
Burner runtime	Hours run of all system parts recorded by the heat source
Water pressure	Displays the operating pressure at the water pressure sensor
Operating code	Displays the appliance status in the form of an operating code (e.g. standby period active) or a fault code

Table 37 System information

Menu: **Energy consumption**

This menu is only available if no cascade module (e.g. MC 400) is installed, and only for certain types of heat source. The information available under the individual menu items are dependent from the installed heat source.

Menu item	description
24h: gas heating	Energy in the form of gas consumed for heating within the last 24 h
24h: elec. heating	Energy in the form of current consumed for heating within the last 24 h
24h: gas DHW	Energy in the form of gas consumed for DHW heating within the last 24 h
24h: elec. DHW	Energy in the form of current consumed for DHW heating within the last 24 h
30d: gas heating	Energy in the form of gas consumed for heating within the last 30 days on a daily average
30d: elec. heating	Energy in the form of current consumed for heating within the last 30 days on a daily average
30d: gas DHW	Energy in the form of gas consumed for DHW heating within the last 30 days on a daily average
30d: elec. DHW	Energy in the form of current consumed for DHW heating within the last 30 days on a daily average

Table 38 Data relating to energy consumption

from external heat sources (e. g. sun light, gas/electric heater etc.). Otherwise undesirable fluctuations of the room temperature may result.

- Never position large objects such as a sofa immediately in front of radiators (maintain a clearance of at least 50 cm). Otherwise, the heated air cannot circulate and heat the room adequately.
- If you reduce the room temperature by 1 K (1 °C), you can save up to 6 % energy.
However, allowing rooms that are heated on a daily basis to drop down to below + 15 °C is not recommended. That would permit the walls to cool down too much. During the heat-up phase, the ambient climate would be disturbed by the cool walls that would still radiate cold. If you then raise the room temperature further, more energy would be spent than with a regular supply of heat.
- With good heat insulation in your building, it is possible that after a heating phase the desired room temperature for the setback mode ☾ will not be reached. Nevertheless, energy is being saved as the heating system stays switched off.
You save further energy if you set the switching time for the setback mode ☾ earlier.

DHW heating on demand

- If the heating periods and the times at which hot water is required are closely aligned, use the time program for DHW heating in automatic mode as well.
- Set the DHW temperature to as low as possible. This saves a lot of energy without noticeably impairing DHW availability and comfort.

7 Energy saving tips

Economy mode

- Use the time program by activating automatic mode. Set the required room temperatures for the heating and setback modes in accordance with your personal temperature preferences. Adjust the time program to suit your lifestyle.
 - Heating mode ☼ = Normal heating
 - Setback mode ☾ = Active living, away from home or asleep.
- Set the thermostatic valves in all rooms so that the required room temperatures can be achieved. Raise the temperatures for the operating modes only if the required room temperature is not achieved after a prolonged period.
- If the controller is installed in your living space, it can capture the room temperature to optimise control accuracy if set up accordingly. Keep the controller away

8 FAQ

Why do I have to set a set point value for the room temperature even though the temperature is not measured?

When you set a set point value for the room temperature you change the heat curve. This also changes the room temperature, because the temperature in the heating system changes.

Why does the room temperature measured with a separate thermometer not correlate with the displayed room temperature?

The room temperature is influenced by a number of different variables. If the controller is installed on a cold wall, it will be affected by the cold temperature of the wall. It will be influenced by the heat from a fireplace or chimney, for example, if it is installed in a warm part of the room. Therefore, a separate thermometer can indicate a different room temperature than that set at the controller. To compare the actual room temperature with the values measured by another thermometer, the following is important:

- The separate thermometer and the controller must be physically close to each other.
- The separate thermometer must be accurate.
- When comparing, do not measure the room temperature when the system is heating up, as the two appliances may react at different speeds to the change in temperature.

If you have followed these instructions and you can still detect a discrepancy, you can calibrate the room temperature display (→ page 34).

Why do the radiators get too hot with a high outdoor temperature?

Even in summer mode radiators can heat up for a short period in special circumstances, such as when the circulation pump starts automatically at a certain interval to prevent it "seizing". If the circulation pump should by chance start immediately after the heating up of hot water the residual heat that is not used is moved away via the heating circuit and the radiators.

Why does the heat pump work at night if the heating is negligible or very little?

There can be different reasons for this. It depends on which setting your installer has made for temperature reduction.

- **Reduced mode:** The heat pump works even when the heating requirement is less to achieve the set room temperature, even if it is low.
- **Outside temperature threshold and Room temperature threshold:** the heating system switches automatically on if

the measured temperature drops below the set value. The heat pump will then start as well.

- **Protection from freezing:** The heating mode is also used to avoid the system freezing if the outdoor temperature drops.

The measured room temperature is higher than the required room temperature. Why is the heat source nevertheless running?

The heat source may be heating hot water.

Your system can be set to three different types of control (→ Chapter 2.3, page 4).

With weather-compensated control (including with room temperature influence), the heat source can still operate even if the measured room temperature is higher than the set room temperature. Adjoining rooms are hence always sufficiently heated without their own controller.

Why does the heating not switch off even though the outside temperature has reached the temperature threshold set for summer shutdown?

Summer shutdown (☀️) based on the outside temperature takes the thermal inertia of the heated building mass into account (delayed effect due to insulation levels and wall construction). Therefore, when the temperature is reached during the transitional period, it takes a few hours before switchover actually occurs.

9 Eliminate fault

9.1 Eliminating "sensed" faults

A "sensed" fault can have various causes, which can usually be eliminated by taking simple steps.

If it is too cold or hot for you, for example, the following table will help you eliminate "sensed" faults.

Problem	Cause	Remedy
Required room temperature not achieved.	Thermostatic valves on the radiators are set too low.	Set the thermostatic valves higher.
	Temperature for heating mode is set too low.	Set the temperature for heating mode higher.
	System in summer mode.	Switch system over to winter mode (→ Chapter 5.3.4, page 25).
	Flow temperature controller on heat source set too low.	Set the flow temperature higher (→ operating instructions for the heat source).
	Air in the heating system.	Bleed the radiators and the heating system.
	Installation location of the outdoor temperature sensor is not optimal.	Contact Installer to install the outside temperature sensor at a suitable installation location.
Required room temperature greatly exceeded.	Radiators become too hot.	Set thermostatic valves in adjoining rooms lower.
		Set temperature for the operating mode concerned lower.
		Set temperature for all operating modes lower.
	If the controller is installed in the reference room, if the installation location of controller is unfavourable, e.g. external wall, close to window, in a draught ...	Contact Installer to install the controller at a suitable installation location.

Table 39 Eliminating "sensed" faults

Problem	Cause	Remedy
Excessive room temperature fluctuations.	Temporary influence of external heat on the room, e. g. from solar exposure, room lighting, TV, fireplace etc.	Contact Installer to install the controller at a suitable installation location.
Temperature rises instead of dropping.	Incorrect time set.	Reset the time
Room temperature too high during setback mode.	The building retains a lot of heat.	Set an earlier switching time for setback mode.
DHW cylinder does not heat up.	DHW temperature ¹⁾ on heat source set too low.	Set the DHW temperature ¹⁾ higher.
	DHW temperature ¹⁾ on heat source not set too low.	Contact Installer to check the settings on the controller.
	If the DHW system is controlled via a module: Flow temperature ¹⁾ on heat source set too low.	Set flow temperature ¹⁾ higher.
	DHW program incorrectly set.	Set DHW program.
The DHW heating configuration does not suit this heating system.	The DHW heating configuration does not suit this heating system.	Contact Installer to check the settings on the controller.
The DHW at the draw-off points is not reaching the required temperature.	Mixer set lower than the required DHW temperature.	If you are in doubt, contact your Installer to come and check the mixer setting.
0 is displayed constantly in the info menu under solar yield even though the solar system is in operation.	Solar system set incorrectly.	Contact Installer to check the settings on the controller.

Table 39 Eliminating "sensed" faults

1) See operating instructions of the heat source for further information.

9.2 Removing a displayed fault



NOTICE: System damage due to frost! The system can freeze up if it is taken out of service due to fault shutdown.

- ▶ Use Tab. 40 to check if the fault can be fixed.
- ▶ If the fault cannot be fixed, contact your Installer immediately.

A fault in your system is indicated on the display of the controller.

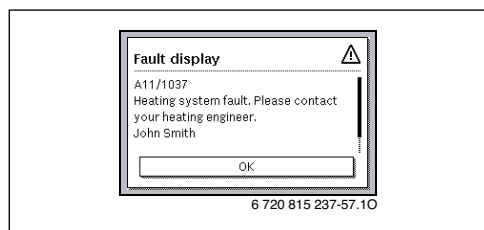


Fig. 6 Error display

If there are multiple faults, the fault with the highest priority will be displayed. Fault codes and sub-codes are displayed. The codes can inform your Installer about the possible cause. Confirm a fault (press the selector) to switch to the standard display. The continued presence of the fault is indicated in the info line. If the fault is still active, it can be restored to the display by pressing the Back key.

The cause can be a fault on the controller, in a component or on the heat source.

The system keeps operating as much as possible; in other words, heating of the home can continue.

Faults you can fix yourself

Fault code	Sub-code	Cause or fault description	Test procedure/Cause	Corrective measure
		Nothing appears on the display	System is switched off.	► Switch on the system.
			The power supply to the controller has been interrupted.	► Check that the controller is correctly seated in its wall bracket.
A01	810	DHW stays cold.	Check if water is possibly being drawn from the DHW cylinder constantly due to taps being open.	► If water is being drawn constantly, take action to stop this.
A01	811	DHW heating: thermal disinfection failed	Check if water is possibly being drawn from the DHW cylinder constantly due to taps being open.	► Take action to stop water being drawn constantly.
A11	1010	No communication via BUS connection EMS 2	–	► Check that the controller is correctly seated in its wall bracket.
A11	1038	Invalid time/date	Date/time not yet set	► Set date/time.
			Prolonged loss of power supply	► Avoid voltage failures.
A11	3061 ... 3064	No communication with heating circuit module (3061: heating circuit 1, ..., 3064: heating circuit 4)	–	► Check that the controller is correctly seated in its wall bracket.
A11	6004	No communication w. solar module	–	► Check that the controller is correctly seated in its wall bracket.
A21 ... A24	1001	–	No BUS connection between Sense II and Sense I in the corresponding heating circuit (A21: heating circuit 1, ..., A24: heating circuit 4).	► Check that the controller is correctly seated in its wall bracket.
A41 A42	4051 4052	Thermal disinfection failed.	Check if water is possibly being drawn from the DHW cylinder constantly due to taps being open.	► Take action to stop water being drawn constantly.
H...	–	–	Maintenance required. The system keeps operating as far as possible.	► Make arrangements to have the system serviced by your Servicing Engineer.
H07	1017	–	Water pressure in the system is too low. This value is only displayed if your system is equipped with a digital pressure sensor.	► Top up the heating water as described in the operating instructions of the heat source.

Table 40

If an operating fault cannot be rectified:

- Contact an authorised installer, or customer service.
Submit error code, additional code and control unit ID number.



Table 41 The control unit ID number must be filled in here by the installer at installation.

Fault affecting the heat source



Heat source faults are always displayed on the heat source.

If there is a BUS connection between the controller and the heat source, faults are also displayed on the controller.

If in doubt, ask your Installer about the type of connection.

Locking faults on the heat source can be rectified by performing a reset.

- ▶ Reset the heat source.

See the operating instructions of the heat source for additional information about eliminating faults affecting the heat source.

- ▶ If the fault cannot be rectified by a reset, contact your Installer.

10 Environment / disposal

Environmental protection is a fundamental corporate strategy of the Bosch Group.

The quality of our products, their efficiency and environmental safety are all of equal importance to us and all environmental protection legislation and regulations are strictly observed. We use the best possible technology and materials for protecting the environment taking into account of economic considerations.

Packaging

We participate in the recycling programmes of the countries in which our products are sold to ensure optimum recycling. All of our packaging materials are environmentally friendly and can be recycled.

Old electrical and electronic appliances



Electrical or electronic devices that are no longer serviceable must be collected separately and sent for environmentally compatible recycling (in accordance with the European Waste Electrical and Electronic Equipment Directive).

To dispose of old electrical or electronic devices, you should use the return and collection systems put in place in the country concerned.

Technical terms



Setback phase

A time slot during automatic mode, with **Setback** operating mode (a lower background temperature).

Automatic mode

The heating system is heating in accordance with the time program and an automatic changeover takes place between operating modes.

Mode

The operating modes for heating are: **Heating** and **Setback**. They are depicted by the symbols  and .

For a constant heating circuit only the **Auto** and **Off** are available (→ Chapter 5.3.2, page 19).

Operating modes for DHW heating are: **DHW**, **DHW reduced** and **Off**.

An adjustable temperature is assigned to each operating mode (except for **Off**).

Instantaneous water heater (combi boiler)

With this type of DHW heating, DHW is available on demand. Compared with DHW heating via a DHW cylinder, it can take longer for the required temperature to be reached at the draw-taps. This delay can be reduced by activating the keep hot function (→ Temperature maintenance).

Frost protection

Depending on the selected frost protection, the heating pump will turn on when the outside and/or room temperature reaches below a certain set threshold. Frost protection prevents the heating system from freezing up.

Required room temperature (also desired or set temperature/set room temp.)

The room temperature to be achieved by the heating system. It can be set individually.

Default setting

Values permanently saved in the programming unit (e.g. complete time programs) that are available at any time and that can be reinstated according to demand.

Heating phase

A time slot during automatic mode, where **Heating** operating mode is active.

Hybrid device and hybrid system

Heating system comprising heat appliances which complement one another with integrated optimisation control. Available as a single unit or separate units (e.g. condensing appliance with

integrated heat pump). The system produces hot heating water to heat a building and may also provide DHW heating.

Cascade

If the performance of one single heat source is not sufficient, several appliances can be “cascaded” for heat production. The appliances can be differently used according to the selected cascade control and can always be controlled so that the required performance is supplied.

Child lock

Settings in the standard display and in the menu can only be changed if the child lock (key lock) is switched off (→ page 12).

Combi boiler

A single heat appliance that can heat both heating water and hot water.

Manual mode

In manual operation, automatic mode (the time program for the heating system) is interrupted and the home is heated constantly to the temperature set for manual operation.

Mixer

A heating system component that automatically ensures that hot water can be drawn from the taps at a temperature no higher than the temperature set on the mixer.

Reference room

The reference room is the room in the home where the controller is installed (or if there is more than one heating circuit, a remote control). The room temperature in this room is fed back to the assigned heating circuit.

Switching time

A certain time at which the heating system starts to heat or hot water is produced, for example. A switching time is a component of a time program.

Temperature of an operating mode

A temperature that is assigned to an operating mode. The temperature is adjustable. See the explanations on operating mode.

Thermal disinfection

This function heats up the hot water to a temperature in excess of 65 °C. This temperature is sufficient to kill off pathogens (e.g. legionella). Observe the anti-scalding safety instructions.

Holiday program

The holiday program enables the settings that would ordinarily be applied to be interrupted for a number of days. After the end of the holiday program, the programming unit resumes operation with the settings that would ordinarily be applied.

Flow temperature

Temperature at which the heated water flows in the central heating system from the heat source to the heating surfaces in the rooms. To reduce heat losses and save energy, today's designs provide for lower flow/return temperatures, e.g. 60/40 °C.

Temperature maintenance

If temperature maintenance is activated for a heat appliance, the heat appliance upstream of DHW heating does not have to be heated according to the instantaneous water heating principle. This makes hot water available more quickly.

Time program for the heating system

This time program ensures automatic changeover between operating modes at defined switching times.

Time program for DHW heating

This time program ensures automatic changeover between **DHW**, **DHW reduced** and **Off** operating modes at defined switching times. It can be linked to the time program for the heating system (→ Chapter 5.4.3, page 26).

Time program for circulation

This time program ensures automatic operation of the DHW circulation pump at defined switching times. Linking this time program to the time program for hot water is **recommended**.

Hot water circulation pump

A hot water circulation pump allows the hot water to circulate between the hot water heater and the taps. In this way you have quick access to hot water at the taps. The circulation pump can be controlled with a time program.

Index

Symbols

..... 9, 18, 23, 37

A

Activating emergency operation 13–14
 Automatic mode 9, 25
 – DHW circulation pump 28
 – Heating system 18, 20
 Automatic time changeover 33

B

Battery backup 5

C

Calibrate temperature sensor 34
 Cascade 4
 Changing the room temperature
 – for heating mode 19
 – for setback mode 19
 – permanently 12
 – Temporarily 10
 – Until the next switching time 10
 Circulation
 – Adapt settings 29
 – DHW circulation pump 28
 Control elements
 – Keys 6
 – Selector 6
 Control types 4
 – room temperature-dependent 4
 – weather-compensated 4

D

Date 12
 DHW system 4
 DHW temperature 12, 26
 Display
 – Contrast 33
 – Display in the event of faults 41
 Disposal 43
 Domestic hot water 17
 – Adapt settings 27
 – System I and II 25
 – Temperature above 60 °C 25
 – thermal disinfection 25

E

Emergency mode 9
 Environment / disposal 43

F

Faults
 – Display in the event of a fault 41
 – Eliminate 39
 – Fault code 41
 – History 41
 – on the heat source 43
 – Sub-code 41
 Frost protection 3

G

Getting started 9

H

Heat sources 17
 Heating circuit 4, 18
 – in the standard display 9
 – rename 18, 20, 23
 Heating system 17
 Holiday 17, 30, 32
 – DHW system 30
 – Heating circuit 30
 Holiday program 30, 32
 – delete 33
 – interrupt 33
 – set 32
 Holiday time 30
 Hybrid systems 17, 34

I

Info key 5, 34
 info menu 34
 Information
 – Domestic hot water 34, 36
 – Energy consumption 38
 – Heating system 34–35
 – Hours run 37
 – Outside temperature 34, 37
 – Software version 37
 – Solar 34, 36–37
 – System 34
 – System information 37
 Internet 37
 – Connection 37
 – Password 33, 37

K

Key lock 13
 Keys 5

L

Language 13, 33
 Login data 37

M

Manual operation 9
 menu button 5
 Mode 9, 21

O

Old appliance 43
 Once-only cylinder charging 12
 – Duration 26
 – Start 26
 – Stop 26
 – Temperature 26

P

Packaging 43
 Password 33
 Power failure 5

R

Range of functions 4
 Recycling 43
 Reference room 4
 Remote control 4, 18, 30
 Renaming the DHW system 30
 Reset
 – Time program for DHW 27
 – Time program for the heating system 20
 Risk of scalding 3
 Room temperature-dependent control 39

S

Selector 5
 Sensor calibration 34
 Set time correction 34
 Setback threshold 18
 Settings 17
 – Heat sources 18
 Software version 34
 Solar system 4
 Standard display 33
 – displayed heating circuit 9
 – Symbols 5
 Summer mode
 – Based on outside temperature 25
 – Switch off the heating system 25
 Switching time
 – add 21
 – bring forward 10, 15
 – delete 21
 – move 21

T

Temperature

– 9
 – Actual DHW temperature 35
 – Actual flow temperature 34
 – DHW reduced 26
 – DHW set temperature 35
 – Domestic hot water 12, 26
 – Once-only DHW charging 26
 – Room temperature 9, 35
 – Set flow temperature 34
 Temperature settings 18
 Thermal disinfection
 – Day 29
 – start 30
 – stop 30
 – Temperature 29
 – Time 29
 Thermostats 4
 Time correction 34
 Time of day 12
 Time program
 – activate for the heating system 18–20
 – adapt automatically for the heating system 25
 – adapt for DHW 27
 – adapt for the heating system 21
 – copy 21
 – for DHW circulation pump 28
 – for the heating system 18, 20–21
 – optimise for the heating system 25
 – rename 18, 20
 – reset for DHW 27
 – reset for the heating system 20
 – select for the heating system 19–20

U

Used appliances 43

W

Weather-compensated control 39



Worcester, Bosch Group
Cotswold Way, Warndon, Worcester WR4 9SW.
Tel. 0330 123 9559
Worcester, Bosch Group is a brand name of
Bosch Thermotechnology Ltd.

worcester-bosch.co.uk

6 720 812 775

WORCESTER, BOSCH GROUP:

TECHNICAL SUPPORT:	0330 123 3366
APPOINTMENTS:	0330 123 9339
SPARES:	0330 123 9779
LITERATURE:	0330 123 9119
TRAINING:	0330 123 0166
SALES:	0330 123 9669



WORCESTER
Bosch Group